

SA001595

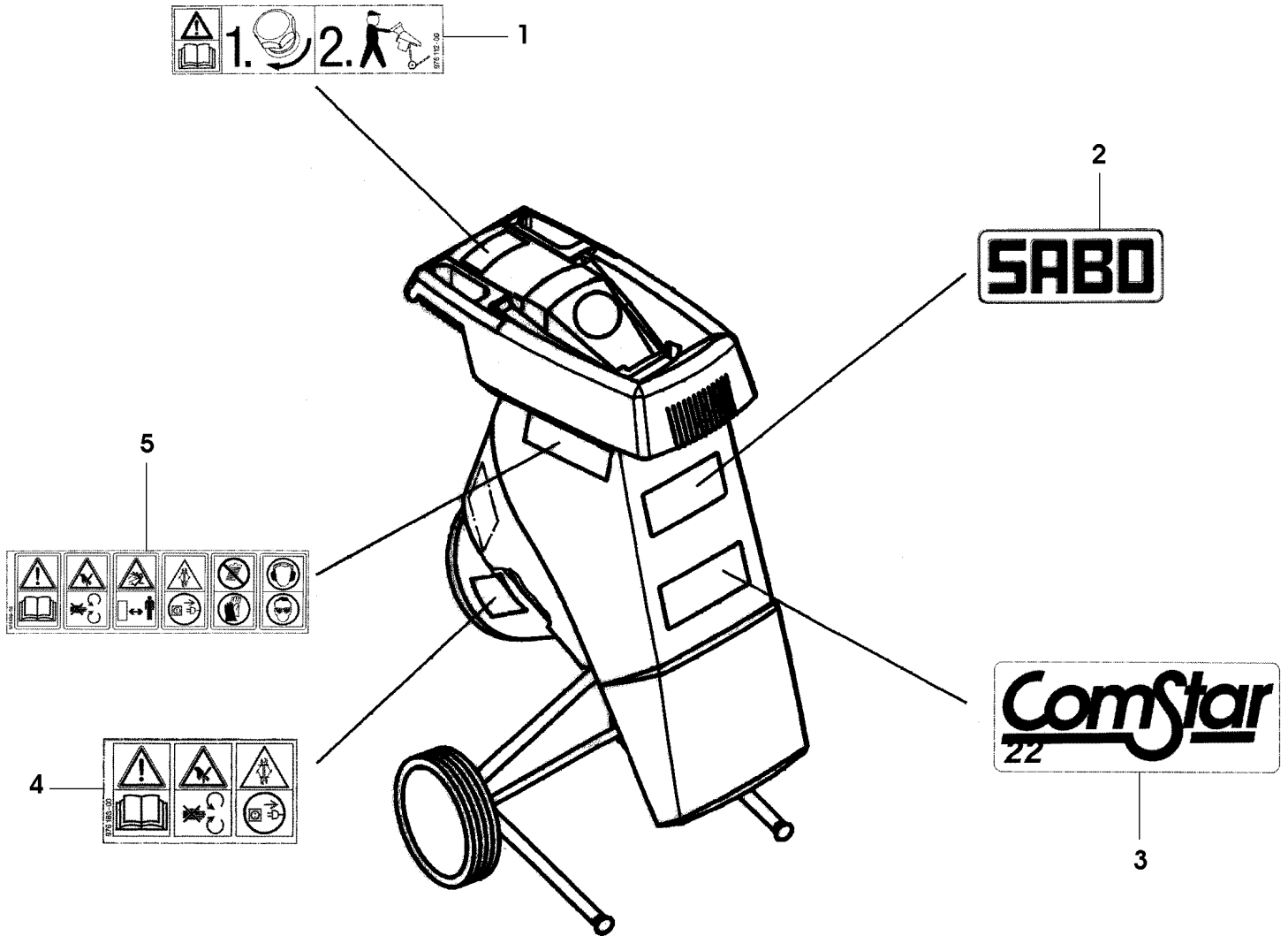

TEIL	STCK.NR	BEZEICHNUNG	STCK.	SER-NR.-	-SER-NR.	BEMERKUNG
1	SA36840	DECKEL	1			
2	SA36838	TRICHTER	2			
3	SA36931	SCHUTZ	3			
4	SA36847	SCHRAUBE	9			EJOT KA40X16
5	SA36966	GEHAEUSE	1			ASSY, UP, INCL KEYS 1, 2, 3, 4, 5, 6, 7, 8, 38, 39, 40
6	SA36873	SCHRAUBE	10			EJOT PT KA50X25
7	SA36939	EINSATZ	1			
8	SA36960	GEHAEUSE	1			LOW
9	SA36935	SCHALTER	1			
10	40M7082	SPRENGRING	1			3,2
11	SA36818	STANGE	1			
12	37M7089	SCHRAUBE	2			M6X12
13	SA36937	ELEKTROMOTOR	1			ASSY, INCL KEYS 14, 16
14		HUELSE	1			
15	SA36932	GEHAEUSE	1			LOW
16	19M7647	SCHRAUBE	4			TORX M8X16
17	SA31843	MAEHMESSERSATZ F. MAEHWER	1			ASSY, INCL KEYS 18, 19, 20
18		MUTTER	4			NSEP
19		MESSER	2			NSEP
20		SCHRAUBE	4			NSEP
21	SA36928	SCHEIBE	1			ASSY, INCL KEYS 17, 22
22		SCHEIBE	1			NSEP
23	SA31845	MAEHMESSERSATZ F. MAEHWER	1			ASSY
24	SA36814	PLATTE	1			
25	19M7163	SECHSKANTSCHRAUBE	1			M8X25
26	SA36813	GEHAEUSE	1			UP
27	SA36876	SECHSKANTSCHRAUBE	2			M8X35
28	19M8579	SCHRAUBE	2			M6X10
29	SA36841	DECKEL	2			
30	SA36882	FEDERMUTTER	2			D12
31	24M7047	UNTERLEGSCHIEBE	4			B13
32	SA36938	RAD	2			ASSY, INCL KEYS 29, 30, 31
33	SA36930	BUEGEL	1			LH (INCL KEY SA36872)
34	SA36872	KAPPE	2			
35	SA36817	RAHMENROHR	1			
36	SA36857	SECHSKANTSCHRAUBE	2			M6X20
37	SA36929	BUEGEL	1			RH (INCL KEY SA36872)
38	SA36816	SICHERUNGSBLECH	1			
39	24M7138	UNTERLEGSCHIEBE	4			B35,3
40	SA36819	SCHEIBE	4			D16XD4,5X1
41	LCA71900	SCHEIBE	1			25X35X0,3
	SA36933	KONDENSATOR	1			30YF
	SA36820	BAND	1			20X3X95
	SA36821	BAND	1			20X3X135
	SA36900	ELEKTR. STECKVERBINDUNG	1			



SA001598



TEIL	STCK.NR	BEZEICHNUNG	STCK.	SER-NR.-	-SER-NR.	BEMERKUNG
1	SA37036	AUFKLEBER	1			
2	SA36724	AUFKLEBER	1			
3	SA36749	AUFKLEBER	1			
4	SA37013	AUFKLEBER	1			
5	SA37014	AUFKLEBER	1			