

SA000615

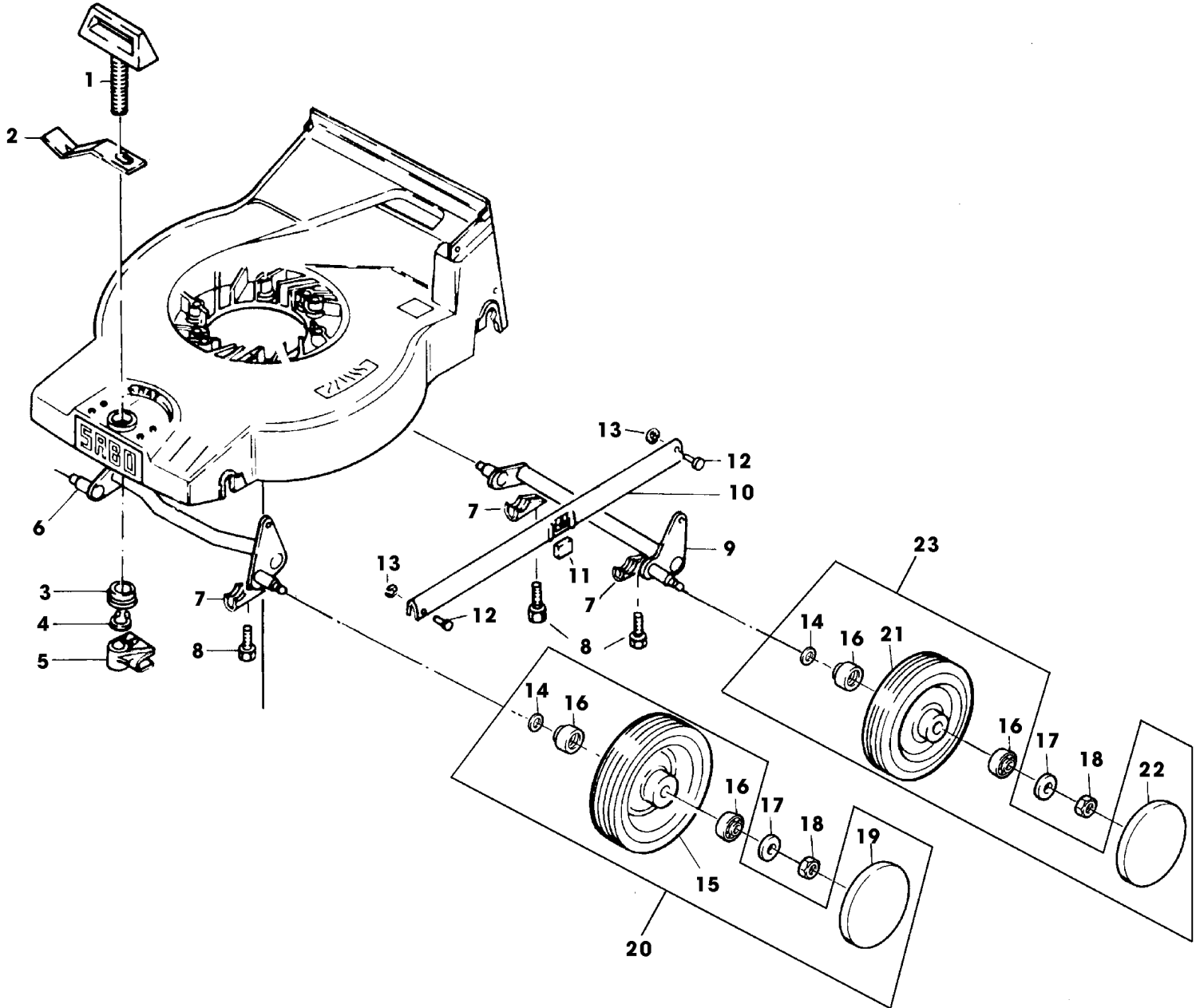

TEIL	STCK.NR	BEZEICHNUNG	STCK.	SER-NR.-	-SER-NR.	BEMERKUNG
1	SAA33428	MAEHGEHAEUSE	1			
2	SA11239	DISTANZSTUECK	4			
3	SA16500	HALTER	1			
4	SA36642	ELEKTROMOTOR	1			1300W
5	SA30966	KONDENSATOR	1			20 MY/F
6	SA11188	SECHSKANTSCHRAUBE	4			M6X50
7	SA16504	SCHEIBE	4			
8	SA11244	SICHERUNGSMUTTER	4			M6
9	SA34517	FUEHRUNG	1			
10	SA34518	ANSCHLAG	1			
11	SA16267	SCHRAUBE	2			4,2X13
12	SA16267	SCHRAUBE	3			4,2X13
13	SA34275	LUFTFUEHRUNG	1			
14	SA16507	HAUBE	1			
15	SA16268	SCHRAUBE	3			4,2X32
16	SA35232	LUEFTER	1			(A) NSEP (ORD SAA10123)
17	SAA15166	MESSER	1			
18	SA34097	FLANSCH	1			(FOR SA35232)
19	SA34273	SCHEIBE	1			
20	SA37472	SCHRAUBE	1			(SUB FOR SA16549)
		(A) TEILESATZ SAA10123 BEINHALTET AUCH FLANSCH SA37318 UND SCHRAUBE SA37472				



SA000525



TEIL	STCK.NR	BEZEICHNUNG	STCK.	SER-NR.-	-SER-NR.	BEMERKUNG
1	SA15168	GRIFF	1			
2	SA15169	FEDER	1			
3	SAA11251	KUGELLAGER	1			
4	SA15691	SPRENGRING	1			9
5	SA15170	SCHALTKONSOLE	1			
6	SA15171	ACHSE	1			FRONT
7	SA36388	KLEMME	4			(SUB FOR SA15174)
8	SA29854	SCHRAUBE	4			M5X12
9	SA15172	ACHSE	1			REAR
10	SA15173	VERBINDUNGSSTANGE	1			
11	SA15191	ANSCHLAG	1			
12	SA17006	BOLZEN	2			6 H11X 13,5
13	H120499	FEDERMUTTER	2			(A) (SUB FOR SA31710)
14	SA35229	UNTERLEGSCHIEBE	4			
15	SA34075	RAD KPL. MIT BEREIFUNG	2			(B) FRONT, 150 MM
16	SA33229	KUGELLAGER	8			
17	SA15213	UNTERLEGSCHIEBE	4			(A) A8,4
18	14M7327	SICHERUNGSMUTTER	4			(A) M8 (SUB FOR SA11998)
19	SA36551	DECKEL	2			FRONT
20	SA35401	RAD	2			ASSY FRONT, 150 MM
21	SA34392	RAD KPL. MIT BEREIFUNG	2			(C) REAR, 180 MM
22	SA36555	DECKEL	2			REAR
23	SAA35403	RAD	2			ASSY REAR, 180 MM
		(A) WERDEN NUR NOCH IN PACKMENGEN GELIEFERT				
		(B) WENN BESTAND AUFGEBRAUCHT BESTELLE BAUGRUPPE SA35401				
		(C) WENN BESTAND AUFGEBRAUCHT BESTELLE BAUGRUPPE SAA35403				

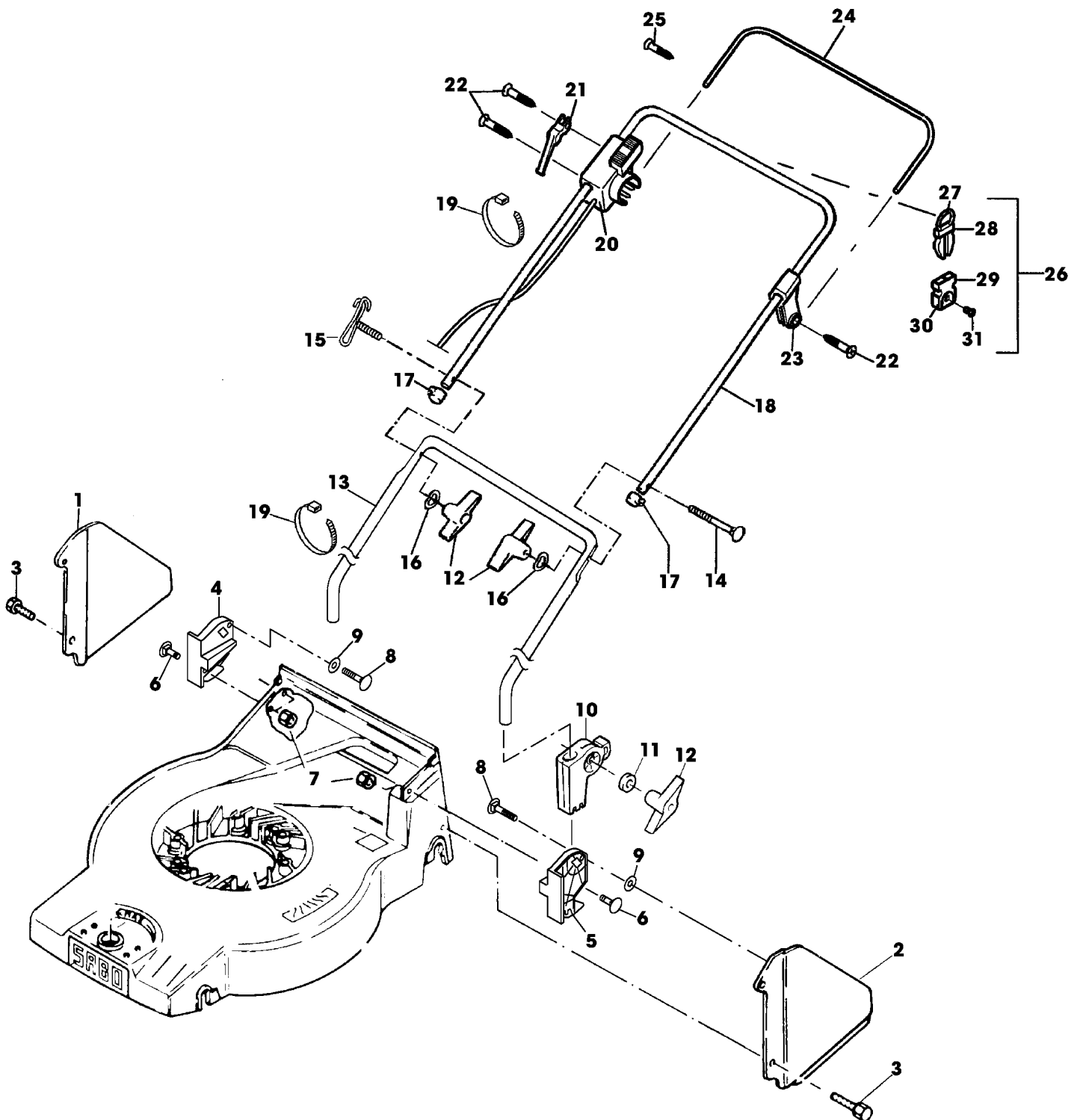

SA002631



TEIL	STCK.NR	BEZEICHNUNG	STCK.	SER-NR.-	-SER-NR.	BEMERKUNG
1	SA35312	ABSTUETZUNG	1			RH
2	SA35313	ABSTUETZUNG	1			LH
3	SA17604	SCHRAUBE	2			(A) M5X10
4	SA36310	HALTER	1			RH
5	SA36311	HALTER	1			LH
6	SA36312	SCHRAUBE	4			M6X25 (ORD SA15324, SA15212, SA37416)
7	SA15412	MUTTER	4			M6
8	SA18797	SCHRAUBE	2			M6X65
9	SA34429	FEDERSCHEIBE	2			
10	SA33256	HALTER	2			
11	SA15212	UNTERLEGSCHIEBE	2			(A) A6,4
12	SA31121	FLÜGELMUTTER	4			
13	SAA36309	FUEHRUNG	1			LOW
14	SA15632	SCHRAUBE	1			M6X45
15	SA35190	FÜHRUNG	1			
16	SA11243	UNTERLEGSCHIEBE	2			
17	SA15893	KAPPE	2			(A)
18	SA35311	LENKSTANGE	1			UP
19	RA1000652	KABELBINDER	2			(SUB FOR SA12505)
20	SA35345	KABELBAUM, ELEKTROMOTOR-	1			(B)
21	SA35202	HALTER	1			
22	SA16267	SCHRAUBE	4			(A) 4,2X13
23	SA34522	LAGER	1			
24	SAA35310	BÜGEL	1			
25	SA17249	SCHRAUBE	1			B 4,8X13
26	SA31745	KABELHALTER	1			ASSY
27		RING	1			NSEP (ORD SA31745)
28		VERRIEGELUNG	1			NSEP (ORD SA31745)
29		KABELHALTER	1			NSEP (ORD SA31745)
30		DECKEL	1			NSEP (ORD SA31745)
31		SCHRAUBE	1			NSEP (ORD SA31745) KBL 50X14
		(A) WERDEN NUR NOCH IN PACKMENGEN GELIEFERT				
		(B) AUSFUEHRUNG SCHWEIZ				

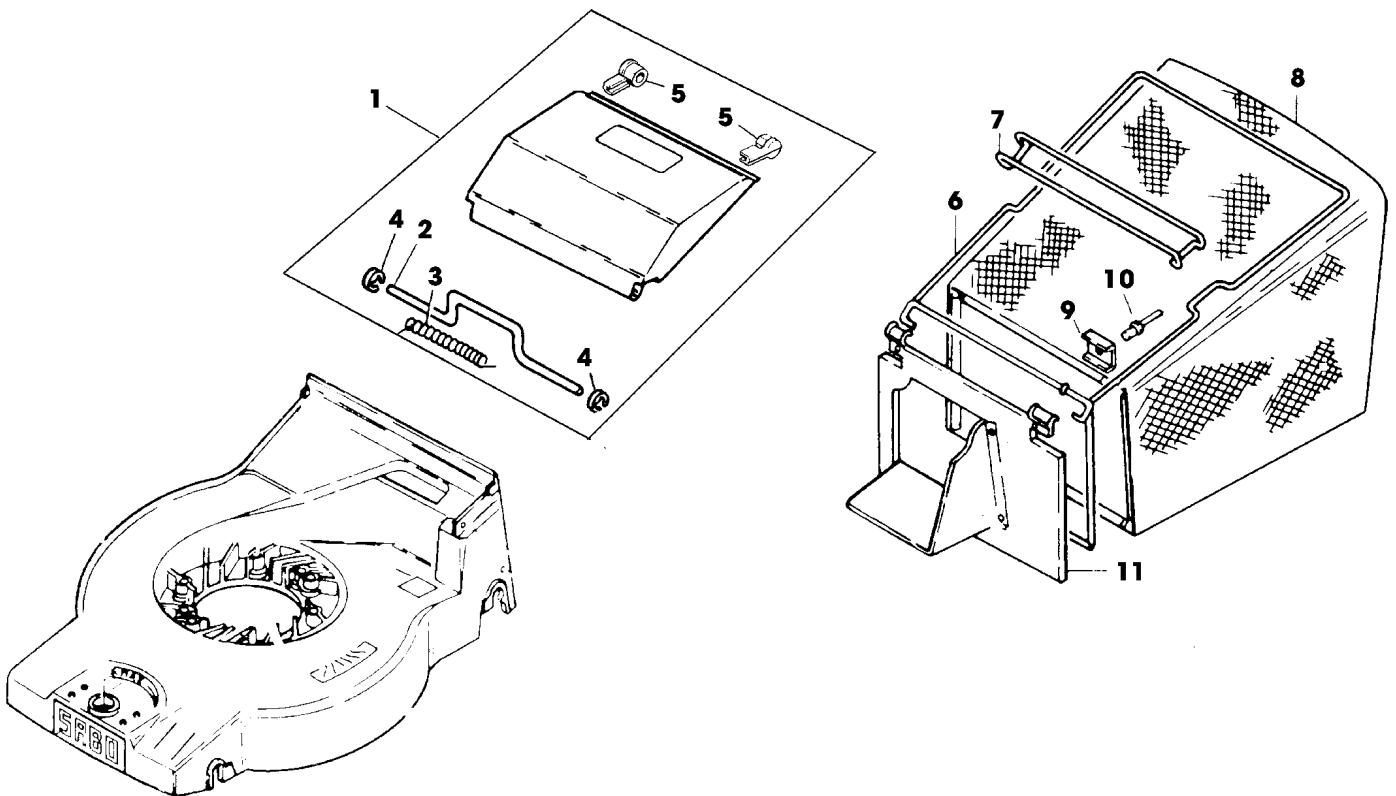

SA000524



TEIL	STCK.NR	BEZEICHNUNG	STCK.	SER-NR.-	-SER-NR.	BEMERKUNG
1	SAA34593	KLAPPE	1			ASSY
2		BUEGEL	1			NSEP (ORD SAA34593)
3		FEDER	1			NSEP (ORD SAA34593)
4		RING	2			NSEP (ORD SAA34593)
5		DAEMPFER	2			NSEP (ORD SAA34593)
6	SAA16556	HALTER	1			
7	SAA16557	GRIFF	1			
8	SA16558	GRASFANGBEHAELTER	1			
9	SA17715	FEDERKLEMME	2			
10		NIET	2			3,9X5,7 (ORD SA15541, SA15200, SA15410)
11	SA16559	KLAPPE	1			

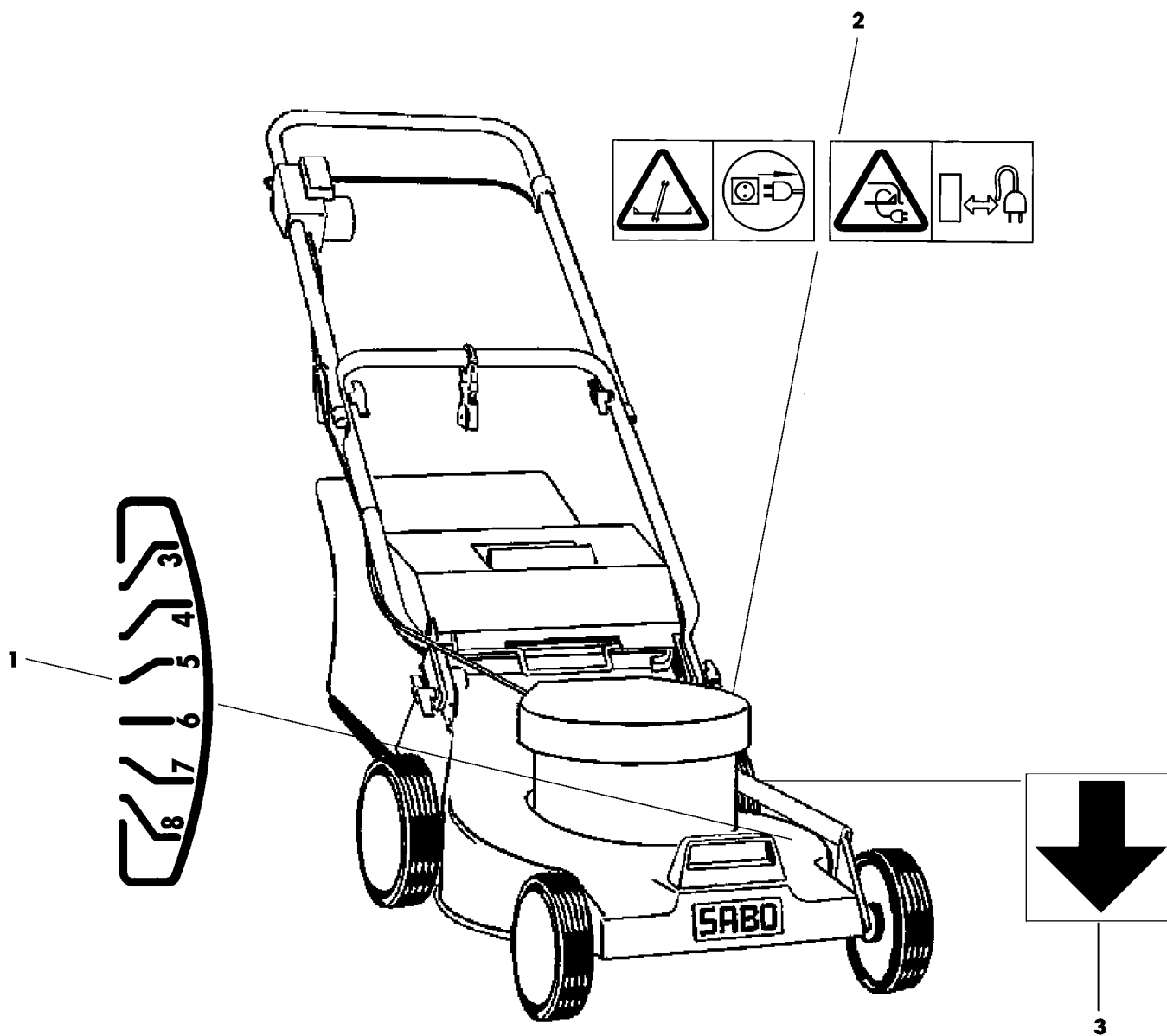

SA001160



TEIL	STCK.NR	BEZEICHNUNG	STCK.	SER-NR.-	-SER-NR.	BEMERKUNG
1	SA16352	AUFKLEBER	1			
2	SA35219	AUFKLEBER	1			
3	SA13820	AUFKLEBER	1			