

[MS 1800](#) > [PRD6200Y \(2014\)](#) > [Elektromotore, Gehäuse, Messer, Räder](#)

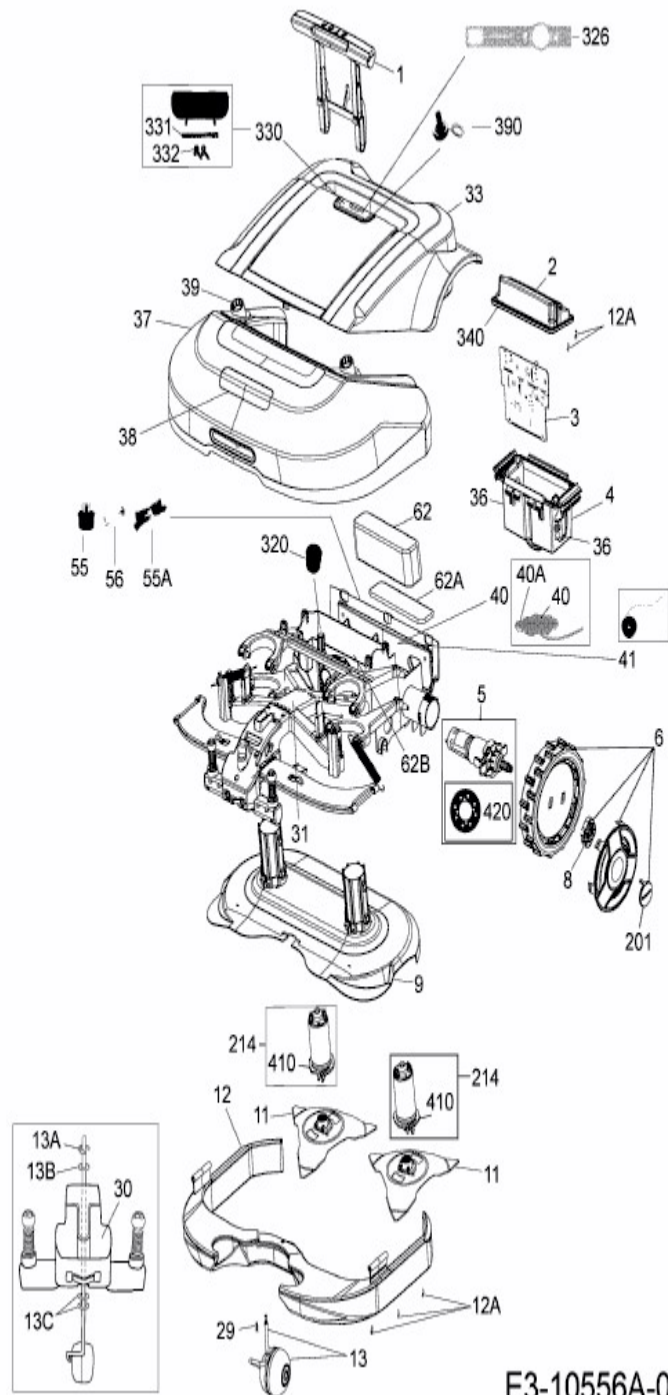

E3-10556A-01