

FÜR 500 SERIE (46"/117CM) > OEM-190-833E (2017) > GRUNDGERÄT

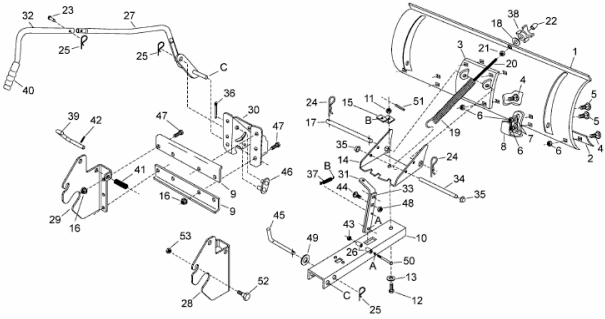

E3-09982B-01