

FÜR 900 SERIE (NX-09) (46"/117CM) > OEM-190-833D
(2013) > GRUNDGERÄT

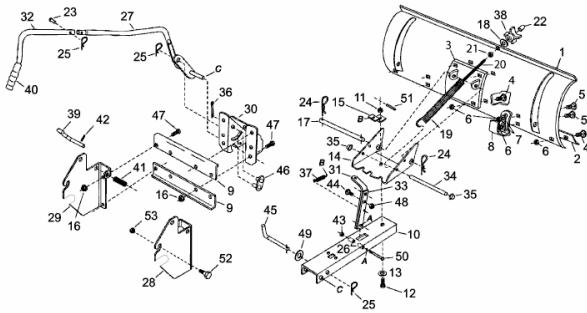

E4-01179C-01