

FÜR 500 SERIE (46"/117CM) > OEM-190-833D (2016) > GRUNDGERÄT

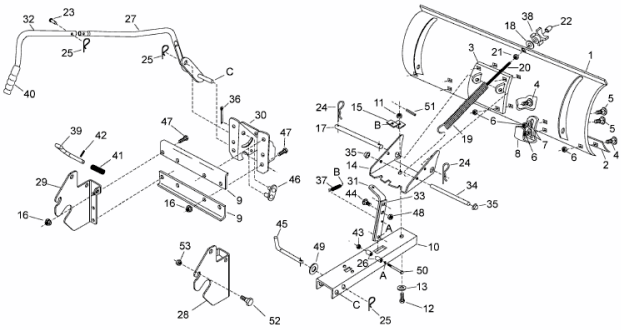

E3-09982A-01