

FÜR 500 SERIE (46"/117CM) > OEM-190-833D (2015) > GRUNDGERÄT

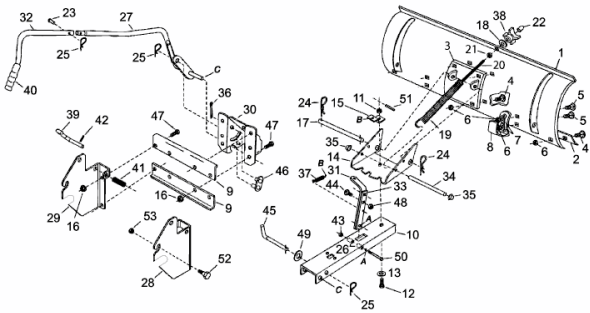

E4-01179C-01