

FÜR 450 SERIE (46"/117CM) > OEM-190-833D (2014) > GRUNDGERÄT

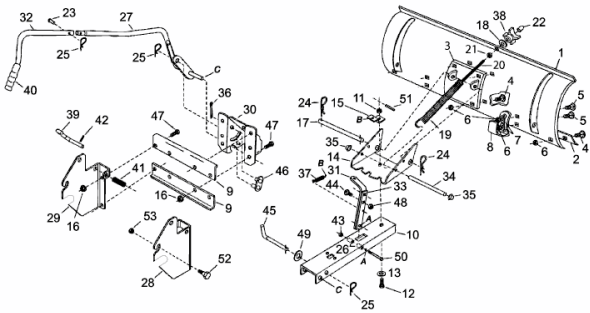

E4-01179C-01