

FÜR 500 SERIE (46"/117CM) > OEM-190-833C (2011) > GRUNDGERÄT

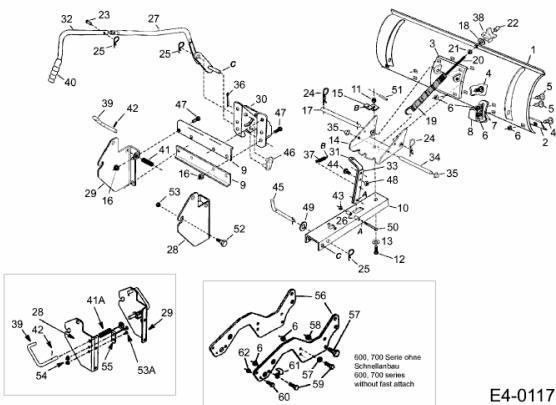

E4-01179B-01