

FÜR 500 SERIE (46"/117CM) > OEM-190-833B (2009) > GRUNDGERÄT

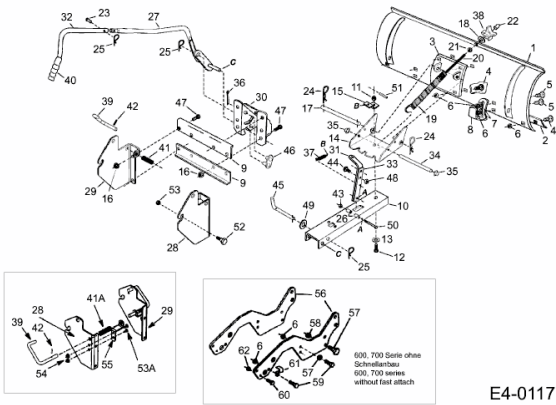

E4-01179B-01