

FÜR 450 SERIE (46"/117CM) > OEM-190-833B (2010) > GRUNDGERÄT

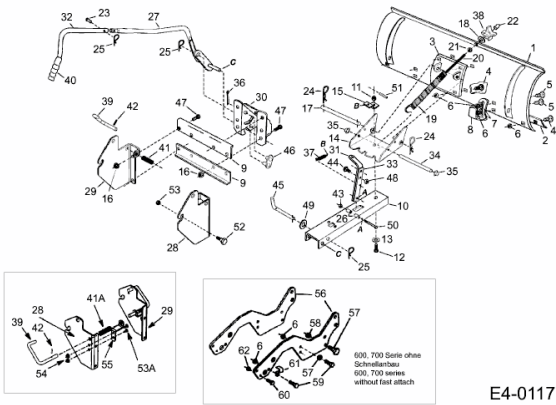

E4-01179B-01