

FÜR 500 SERIE (46"/117CM) > OEM-190-833 (2008) > GRUNDGERÄT

OEM-190-833 46"

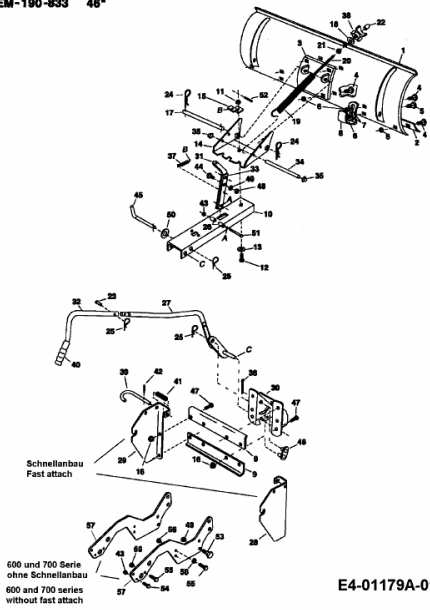

E4-01179A-01