

FÜR GT MODELLE (42"/107CM) > OEM-190-032 (2010) > FRÄSANTRIEB, KEILRIEMEN

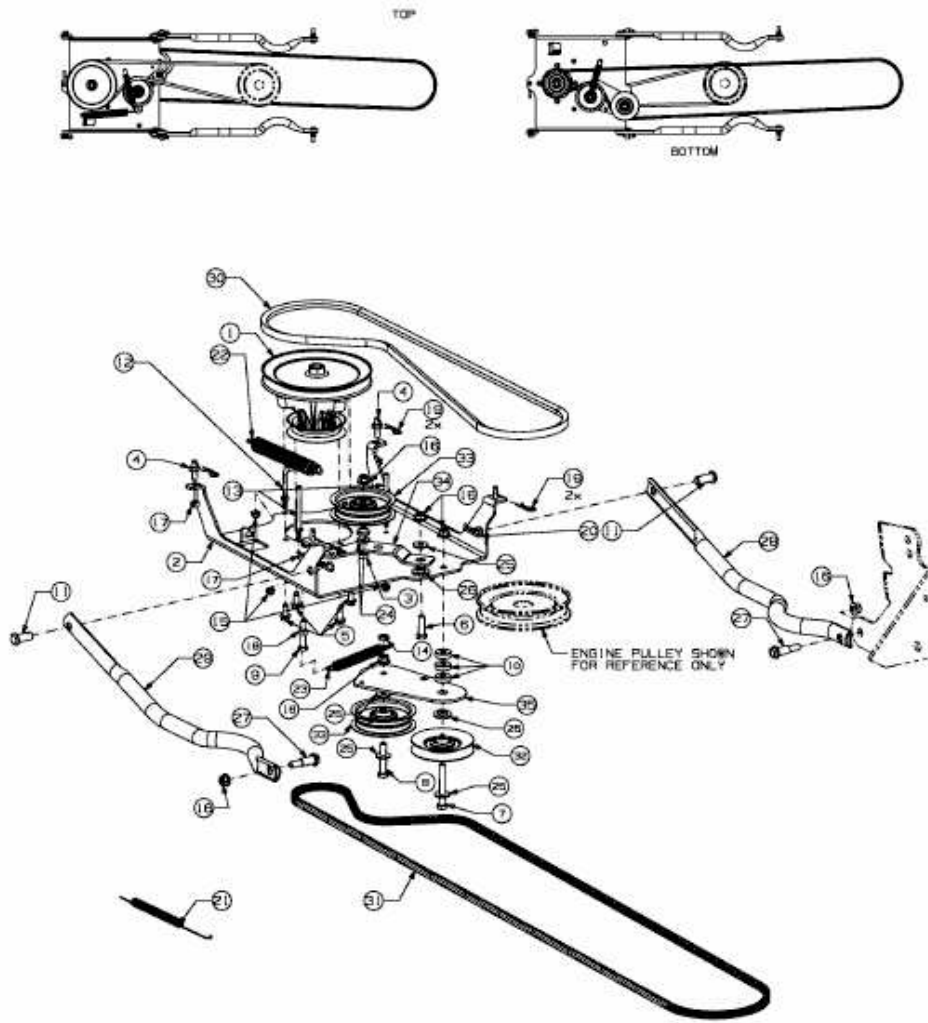

E3-07275A-01