

FÜR CC 1000 SD SERIE (42"/107CM) > OEM-190-032
(2015) > FRÄSANTRIEB, SCHAUFELRAD

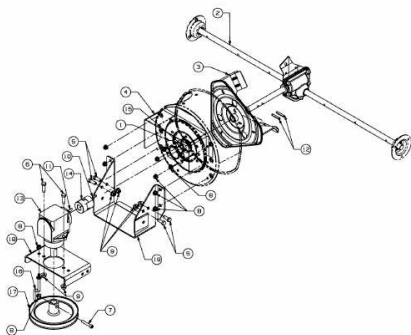

E3-07278A-01