

---

FÜR 900 SERIE (NX-09) (42"/107CM) > OEM-190-032  
(2011) > FRÄSANTRIEB, SCHAUFELRAD

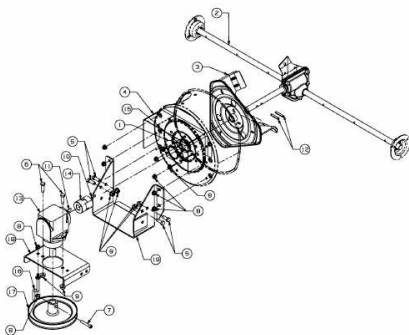

E3-07278A-01