

---

FÜR 800 SERIE (RT-99) (42"/107CM) > OEM-190-032  
(2014) > FRÄSANTRIEB, SCHAUFELRAD

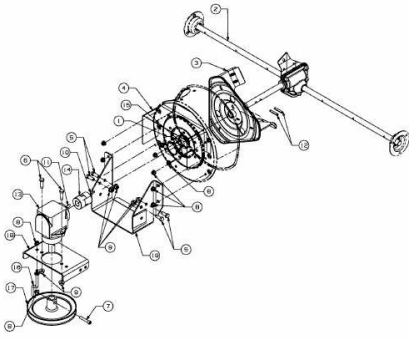

E3-07278A-01