

FÜR 600 SERIE (RT-99) (42"/107CM) > OEM-190-032
(2014) > FRÄSANTRIEB, KEILRIEMEN

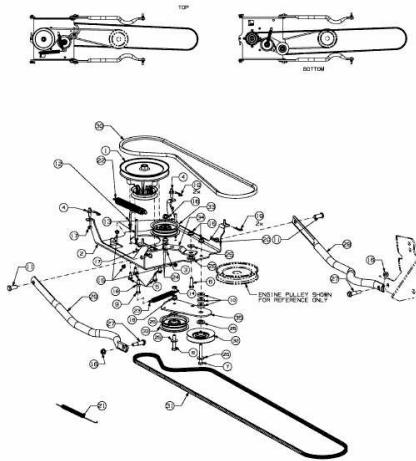

E3-07275A-01