

1 P 61 RH > 752Z1P61RH (2011) > REVERSIERSTARTER, LÜFTERHAUBE

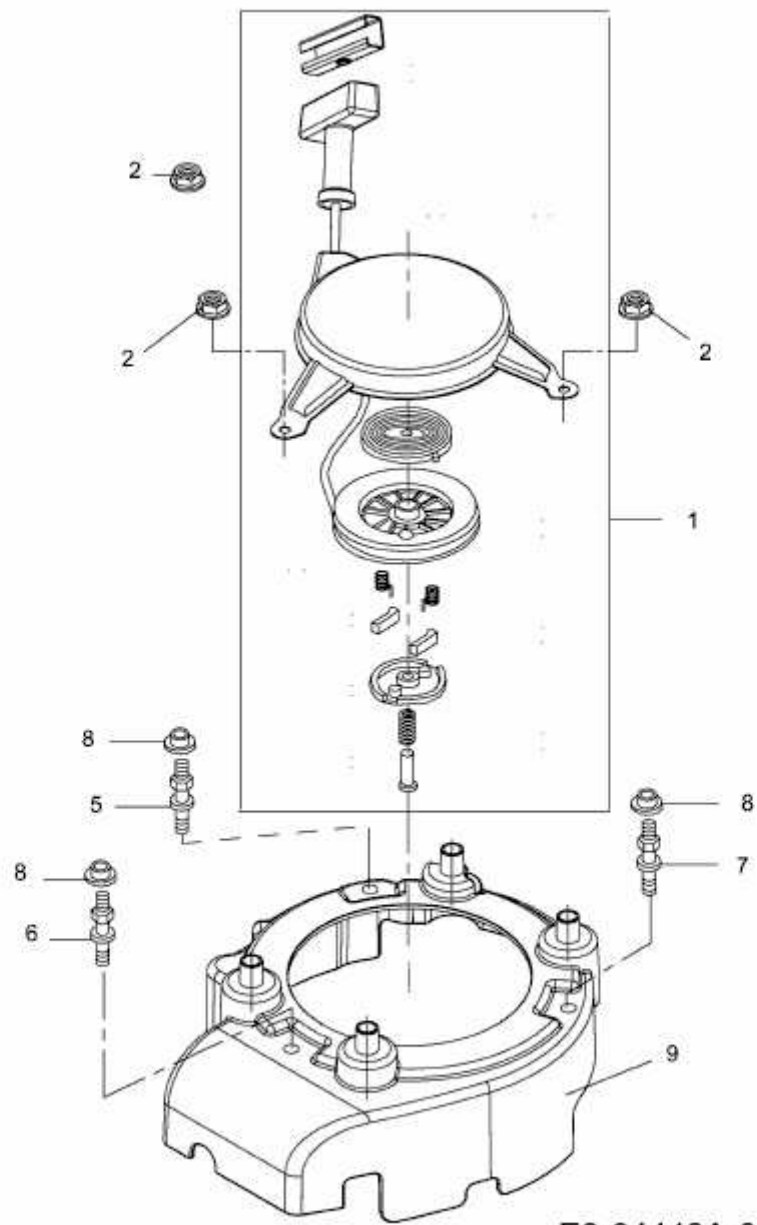

E3-04443A-01