

RE-K > 7282000 (1996) > GRUNDGERÄT

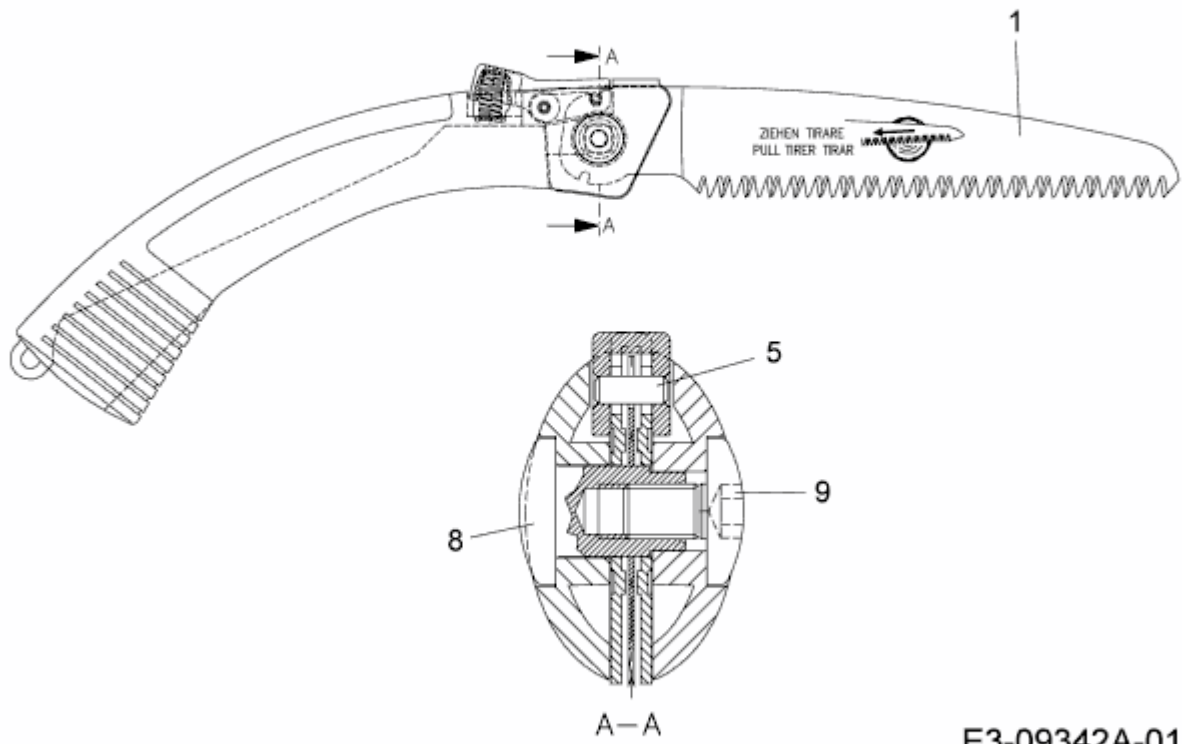

E3-09342A-01