

ab 15.03.2012
from 15.03.2012
à partir du 15.03.2012

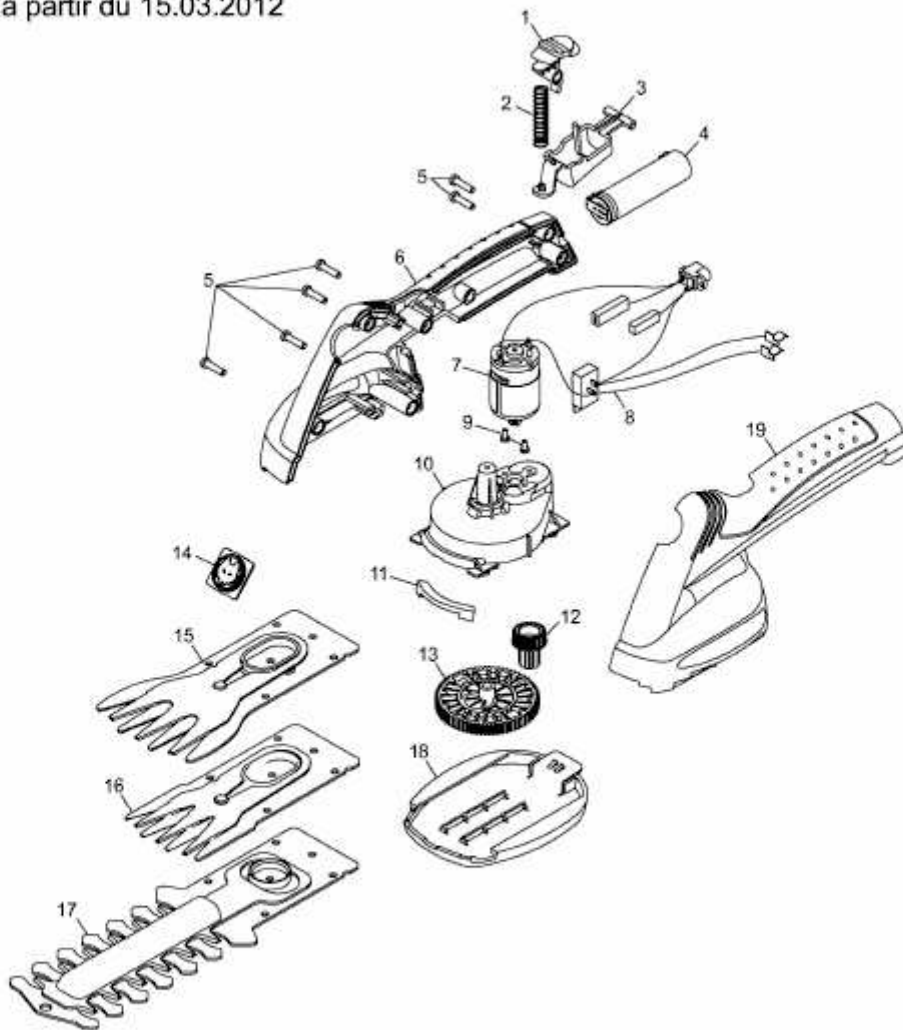

E3-06941C-01