

GT 845 > 7135002 SERIE A (2004) > GRIFF, SCHALTER

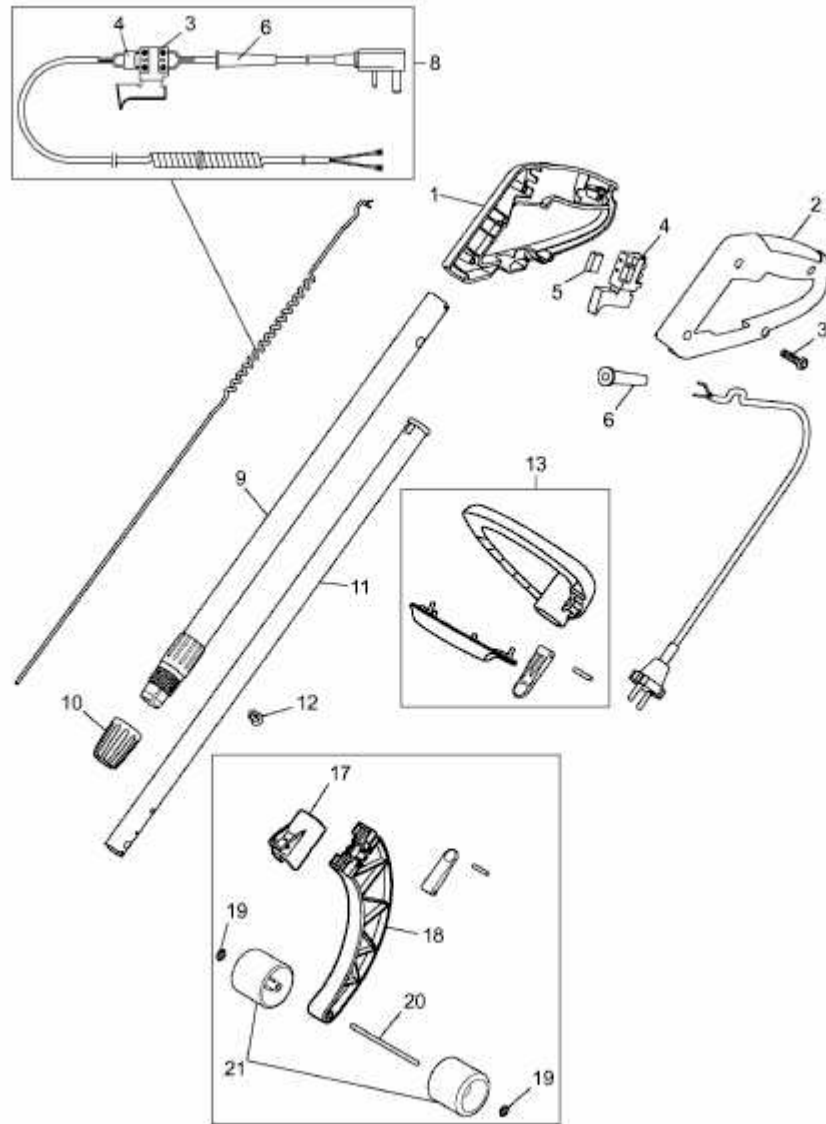

7135002A-1