

GT 840 > 7130003 (2012) > HANDGRIFF, SCHALTER, STIEL

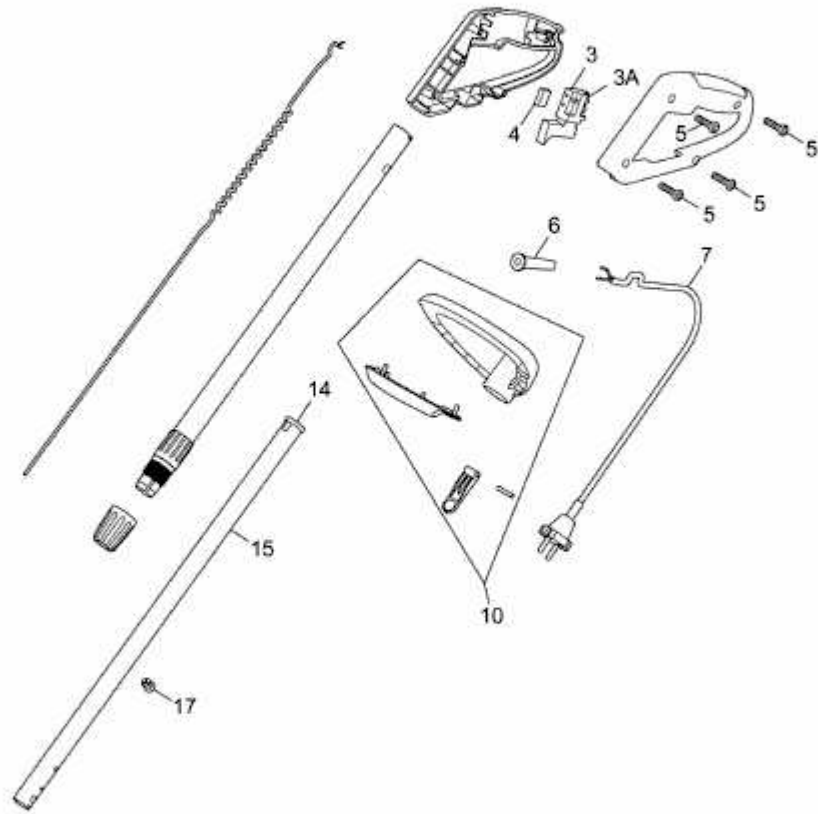

E3-07734A-01