

GT 830 > 7128006 SERIE A (2007) > ELEKTROMOTOR, FADENSPULE

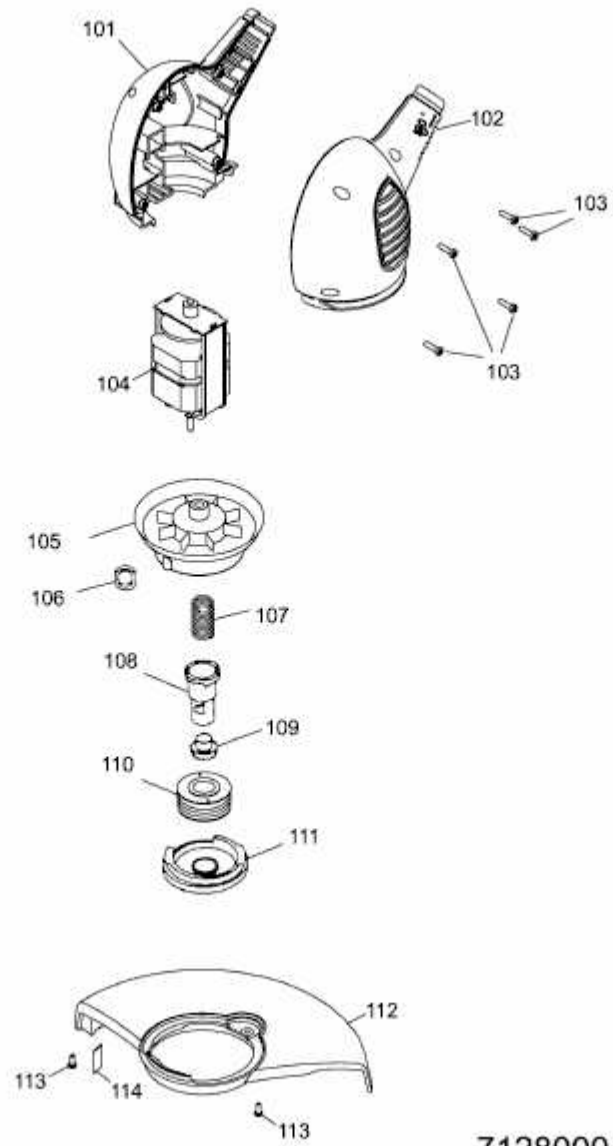

7128000A-2