

GT 830 > 7128006 SERIE A (2007) > GRIFF, SCHALTER

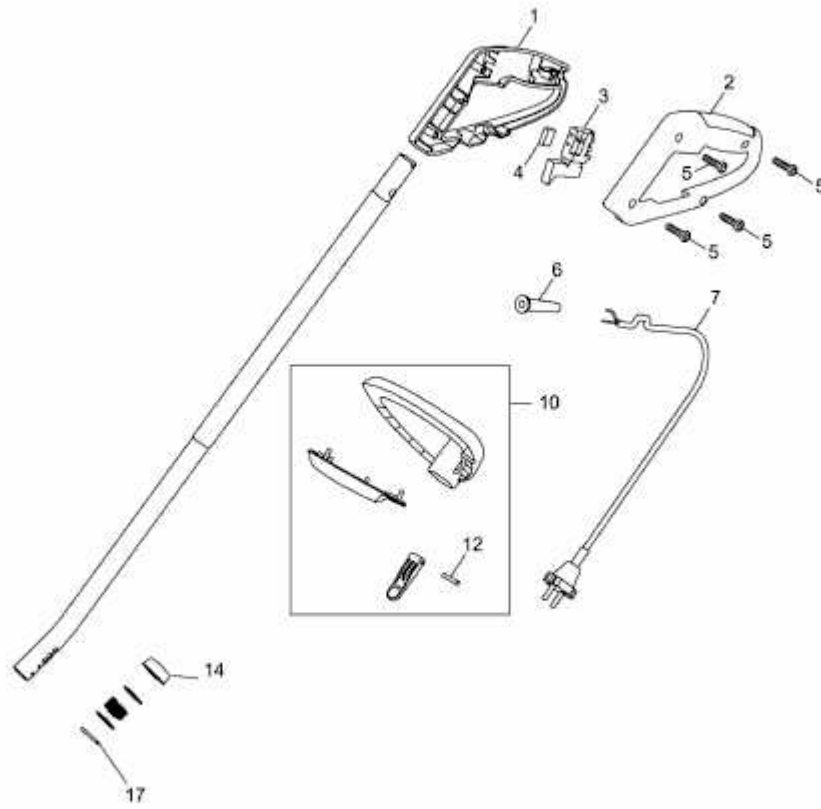

7128000A-1