

GT 830 > 7128003 SERIE A (2007) > ELEKTROMOTOR, FADENSPULE

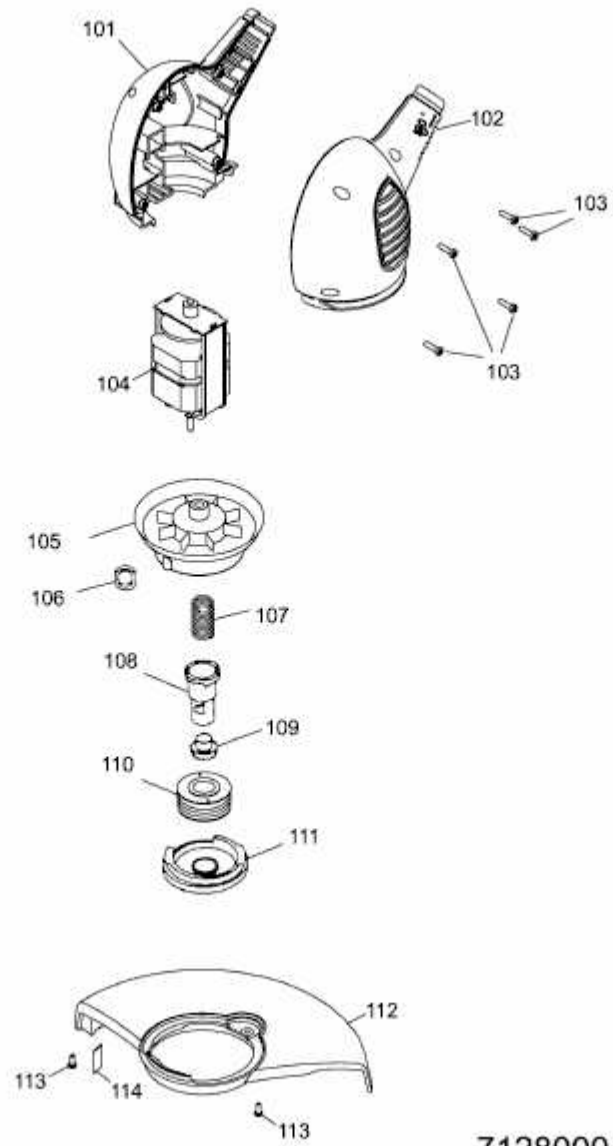

7128000A-2