

FÜR CC 2000/3000 RD SERIE > 596-239-600 (2011) > GRUNDGERÄT

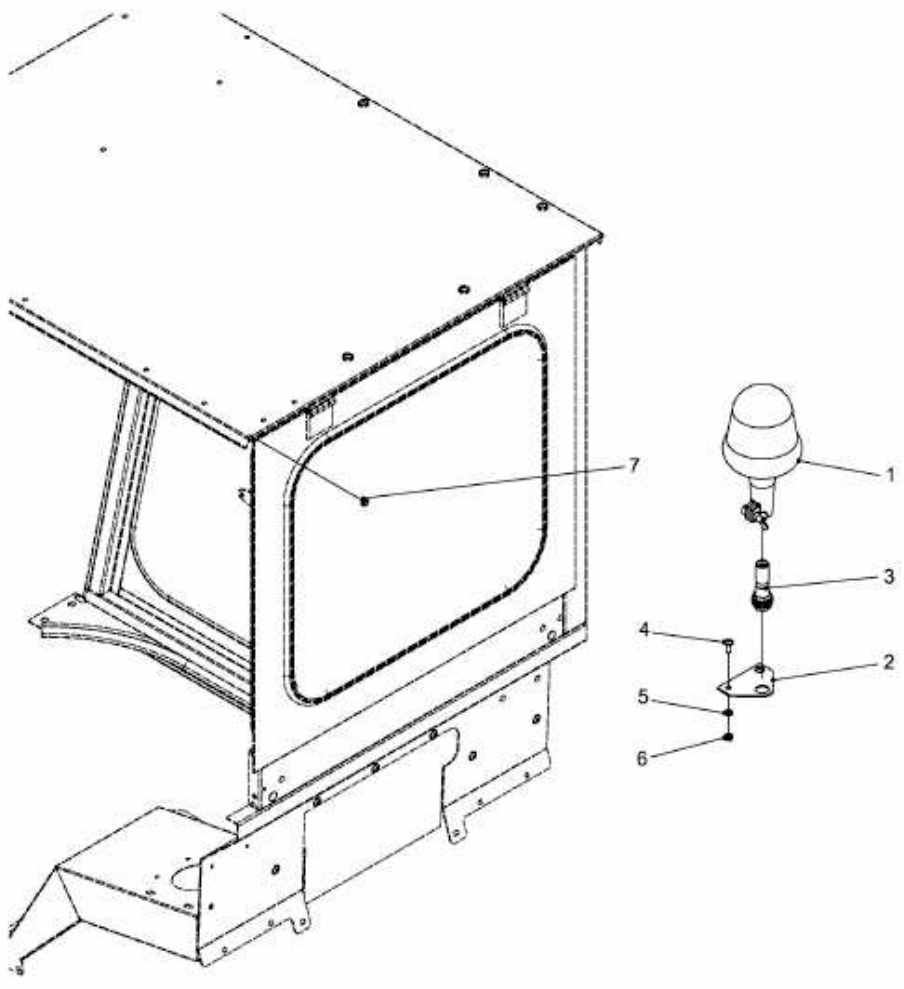

E3-05141A-01