

54AD74HD603 (2007) > SCHAUFEL 16"

590-471-100

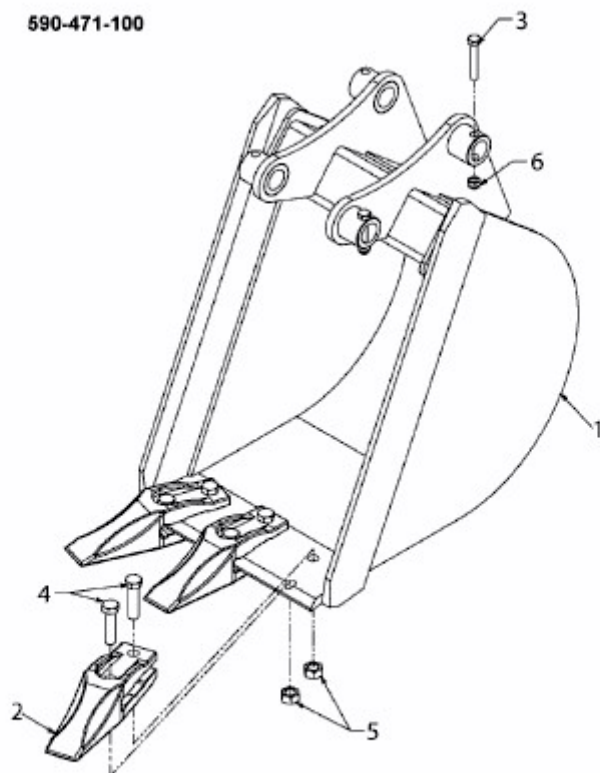

E3-02827A-01