

54AD74HD603 (2007) > ÜBERROLLBÜGEL

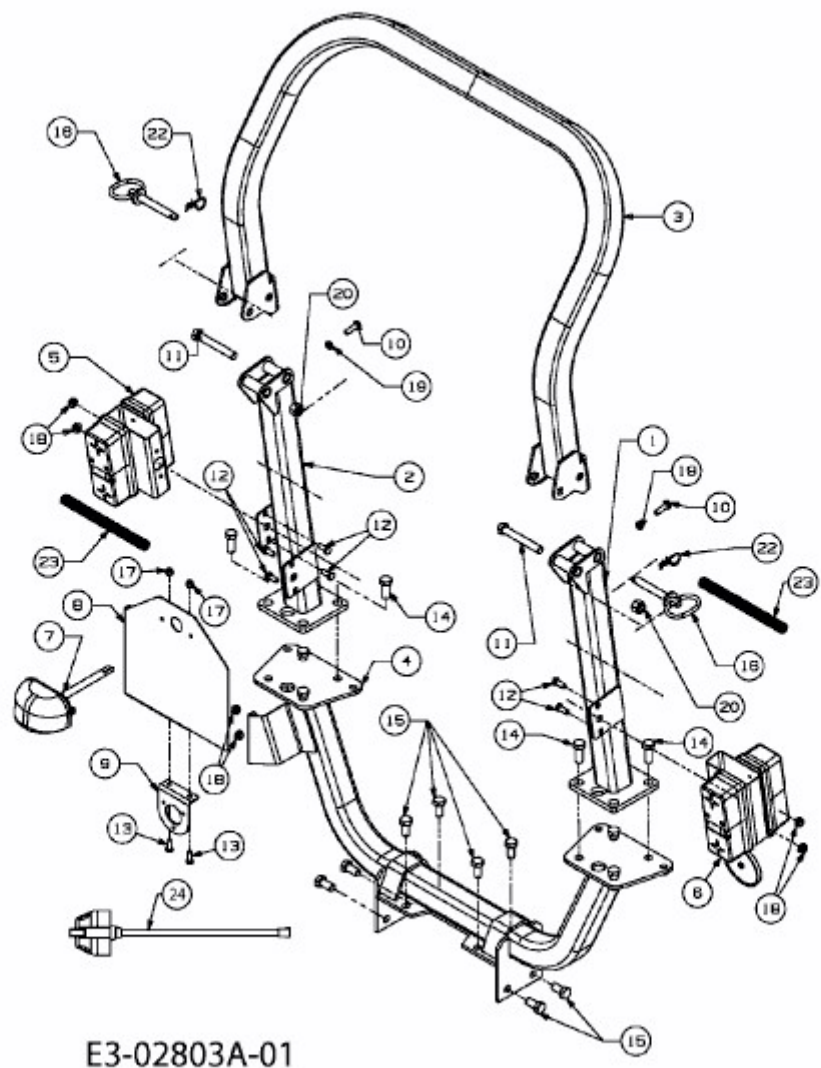

E3-02803A-01