

54AD74HD603 (2007) > GETRIEBEBEFESTIGUNG, HINTERACHSE

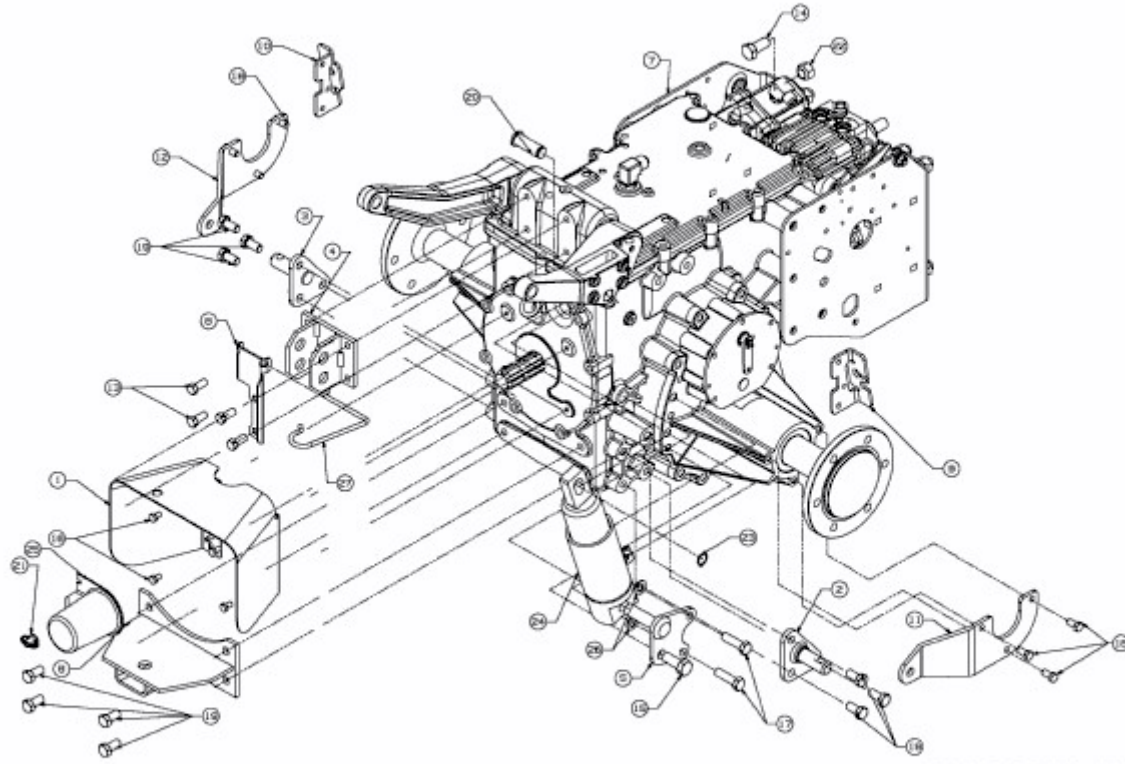

E3-02801A-01