

54A1G8RU603 (2010) > AUSHEBUNG FANGKORB, HECKPLATTE

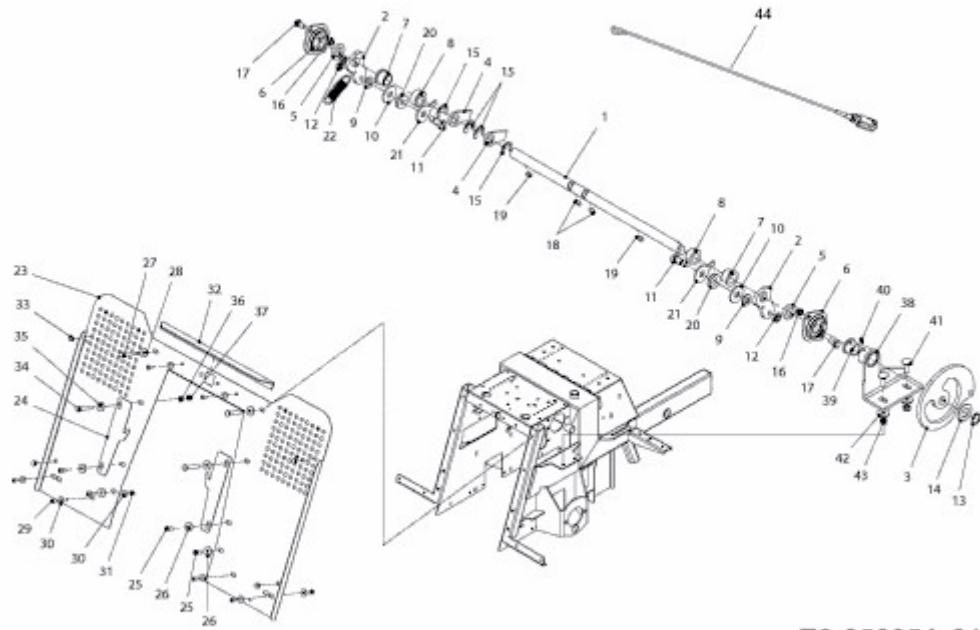

E3-05035A-01