

54A1G8RU603 (2009) > HYDRAULIKLEITUNGEN

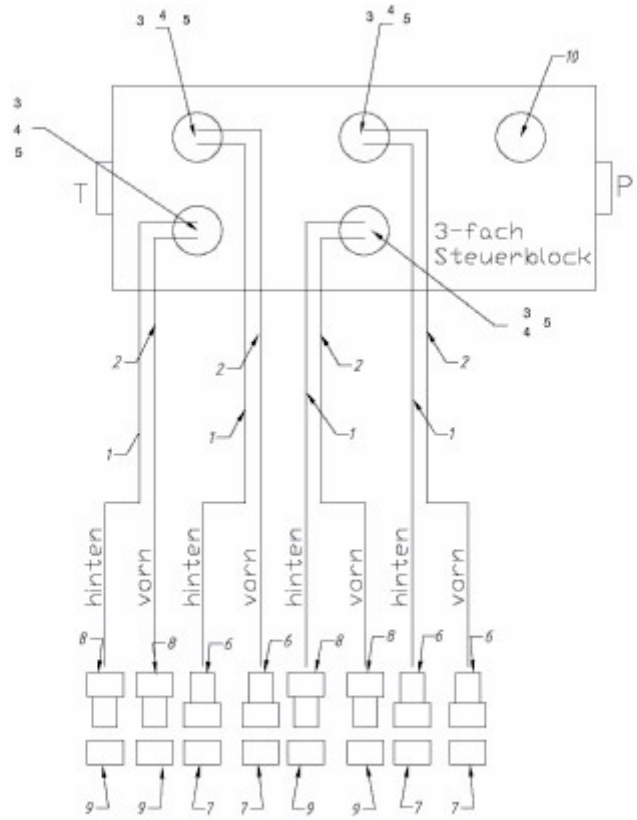

E3-05037A-01