

54A1G8RU603 (2009) > ELEKTROMAGNETKUPPLUNG, LENKUNG, RAHMEN

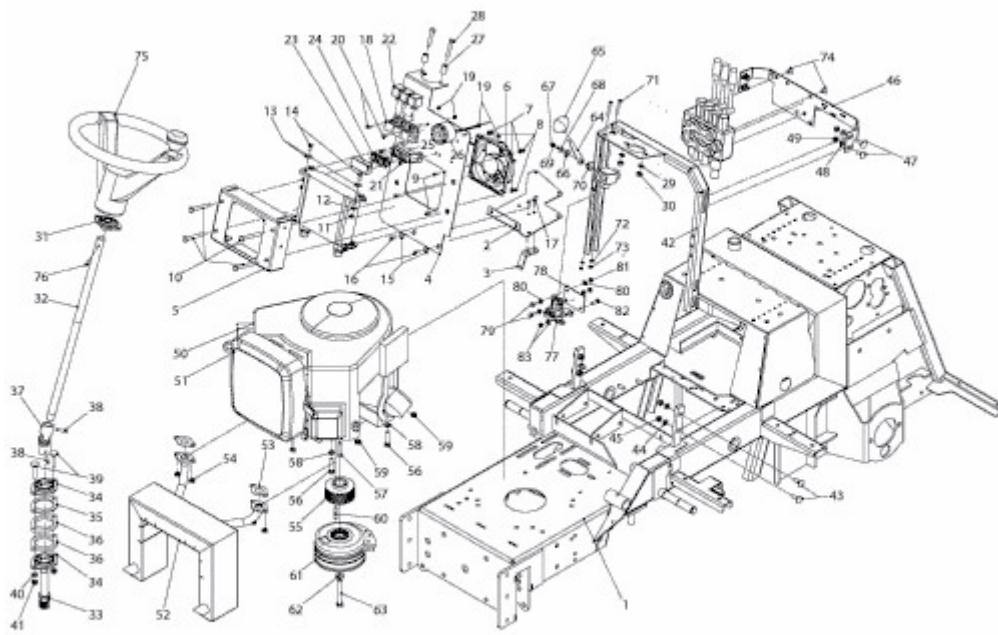

E3-05031A-01