

54A1G8RU603 (2009) > RÄDER VORNE, VORDERACHSE

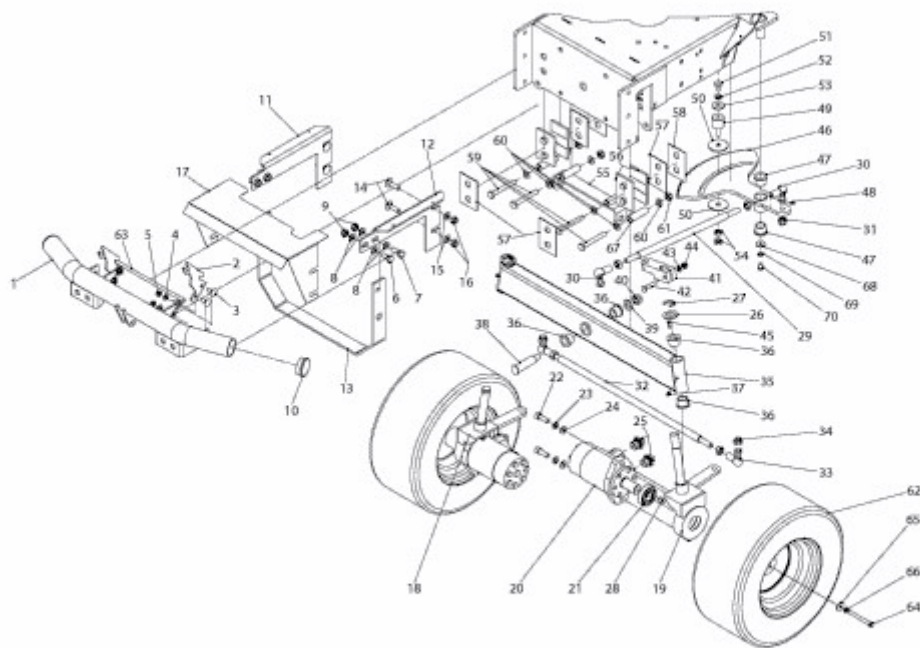

E3-05030A-01