

WE 330 > 5429000 (2014) > GRUNDGERÄT

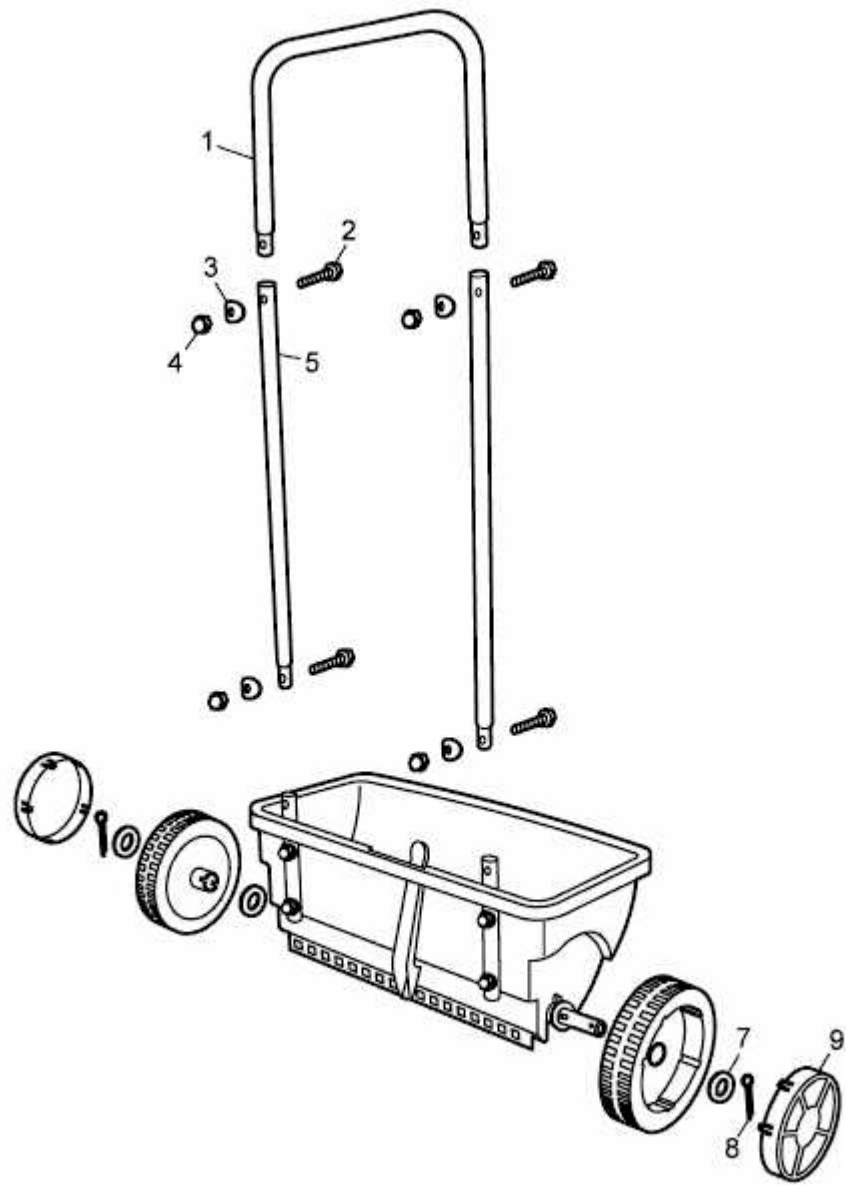

5429000-1