

Z 42 > 53BA1B2G603 (1999) > VORDERACHSE

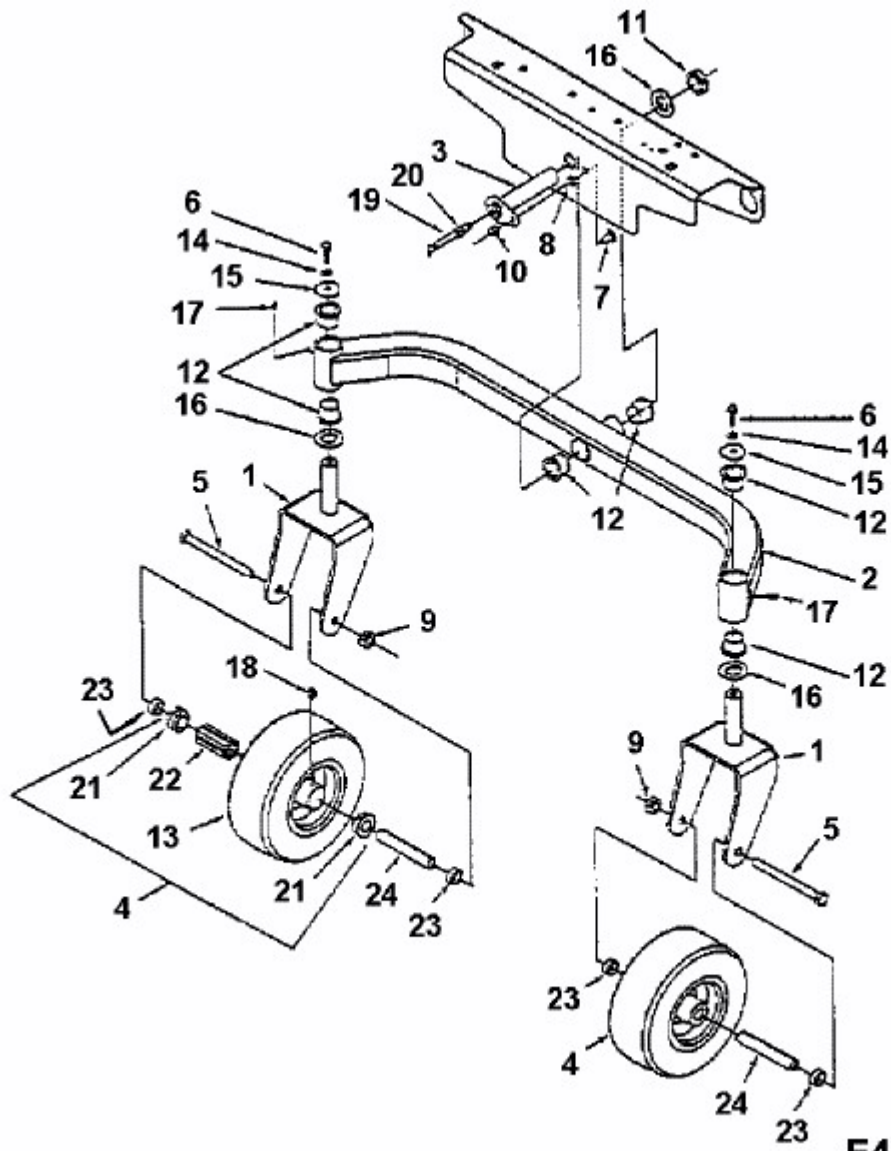

fig

E4-00187A-01