

Z 42 > 53BA1B2G603 (1999) > PEDALE

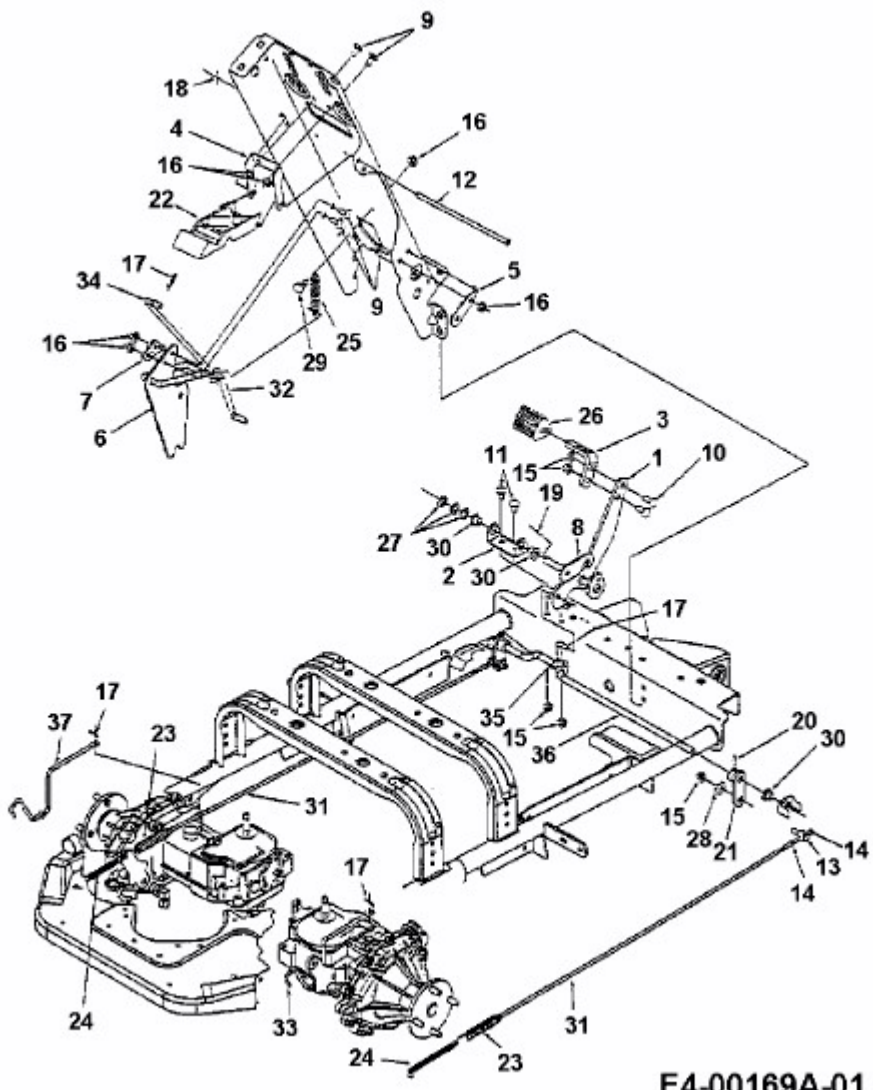

E4-00169A-01

fig