

ab 04.11.2015  
from 04.11.2015  
à partir du 04.11.2015

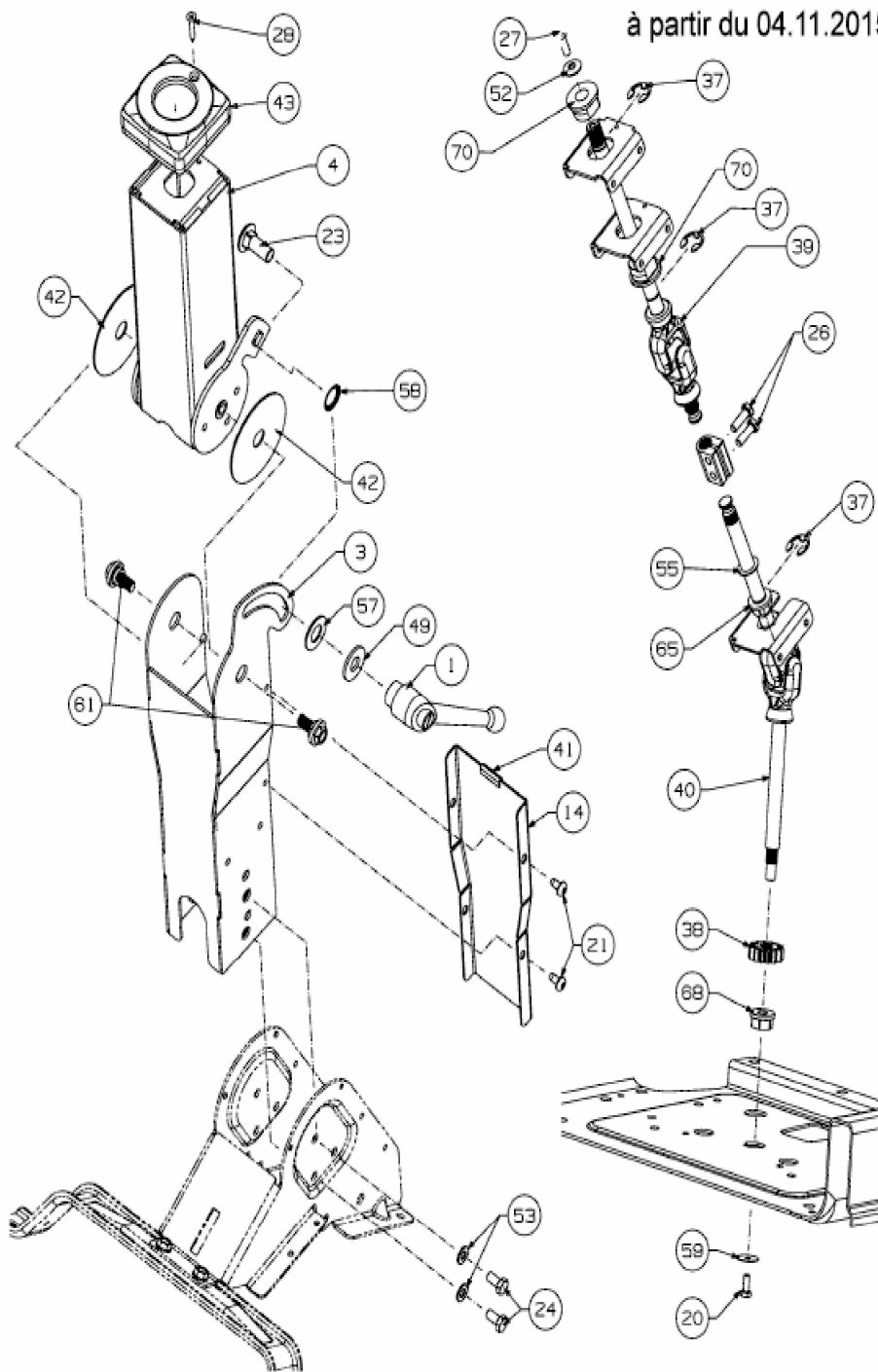

E3-09837A-01