

5

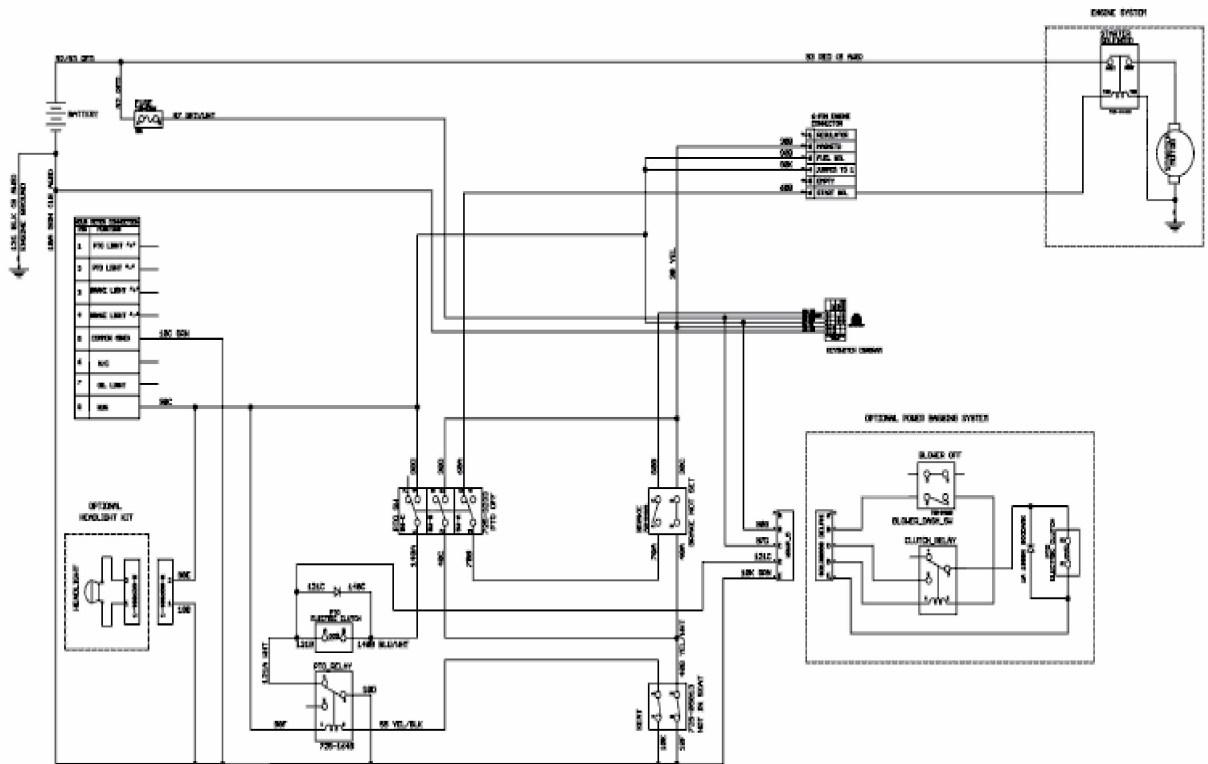

E3-10477A-02