

TANK SZ 60 COMMERCIAL > 53AI2PUD603 (2015) > CHOKEZUG, GASZUG,  
MOTORKEILRIEMENSCHIBE, MOTORZUBEHÖR

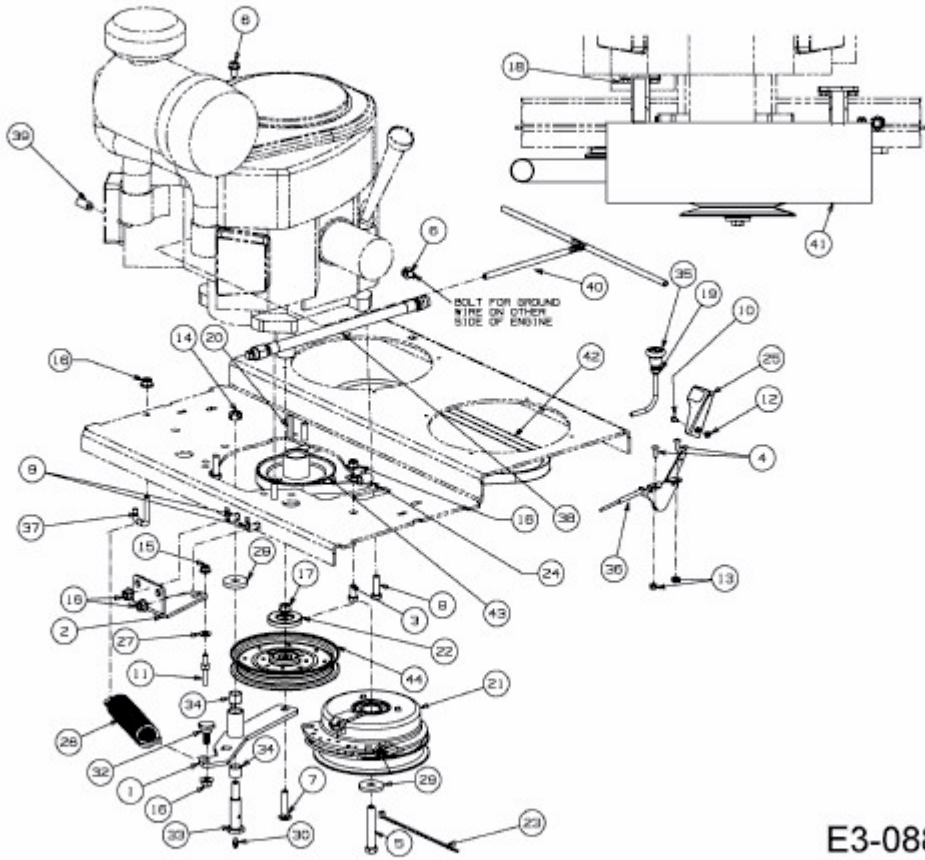

E3-08873A-01