

TANK SZ 60 COMMERCIAL > 53AI2PUD603 (2015) > LENKRAD, LENKSÄULE

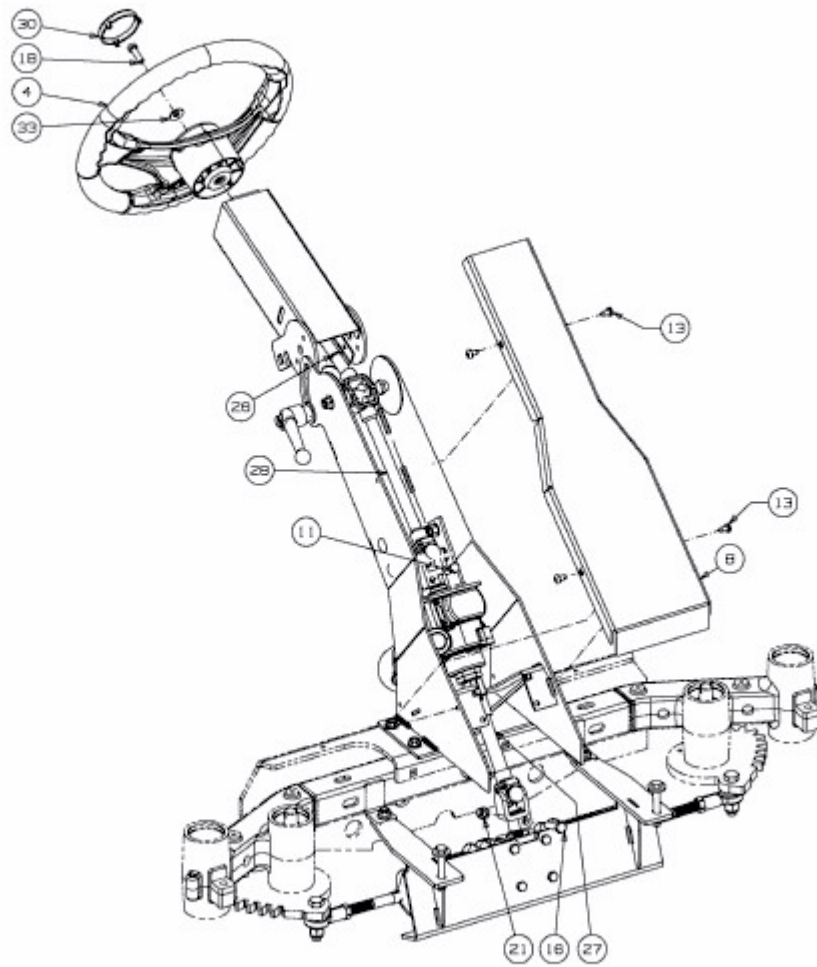

E3-08870A-02