

ab 03.01.2015  
from 03.01.2015  
à partir du 03.01.2015

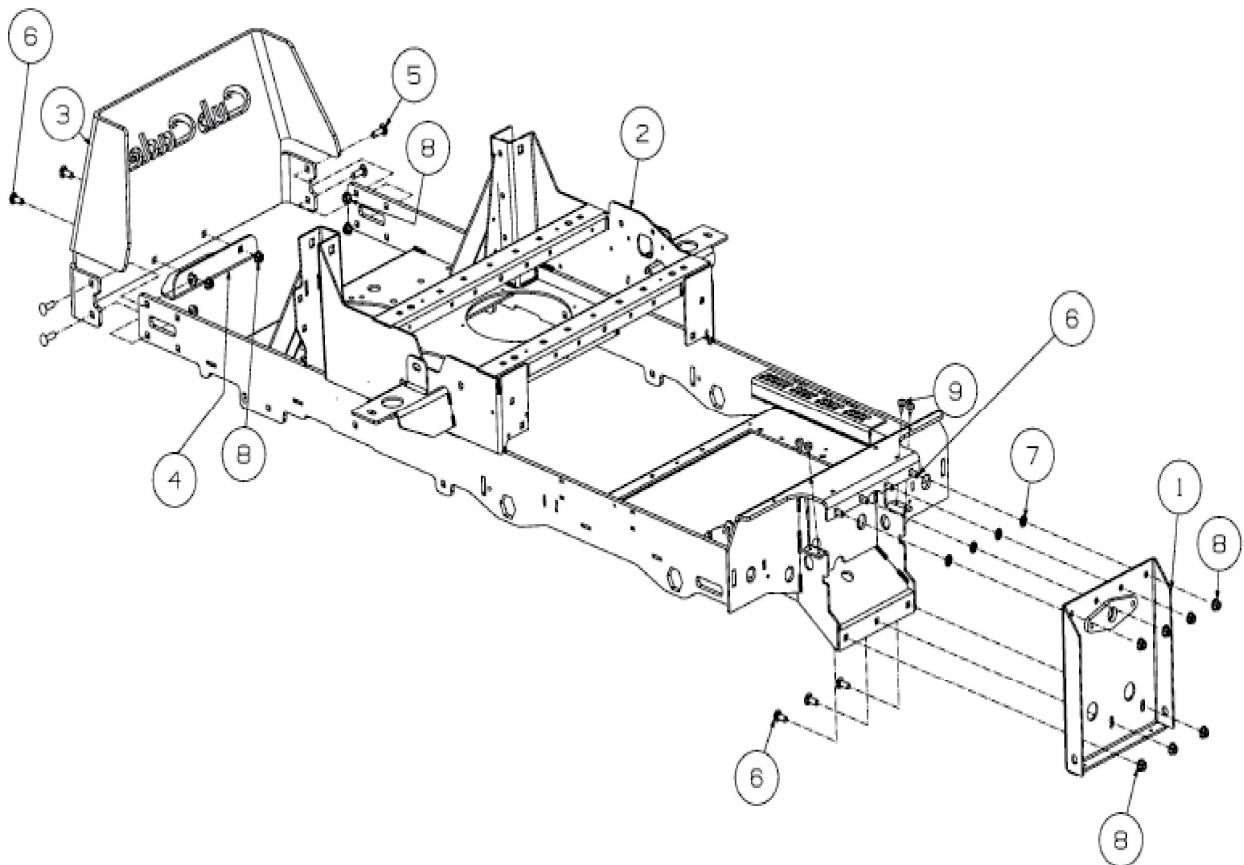

E3-09266A-01