

WS 80 Z > 5223000 (2017) > GRUNDGERÄT

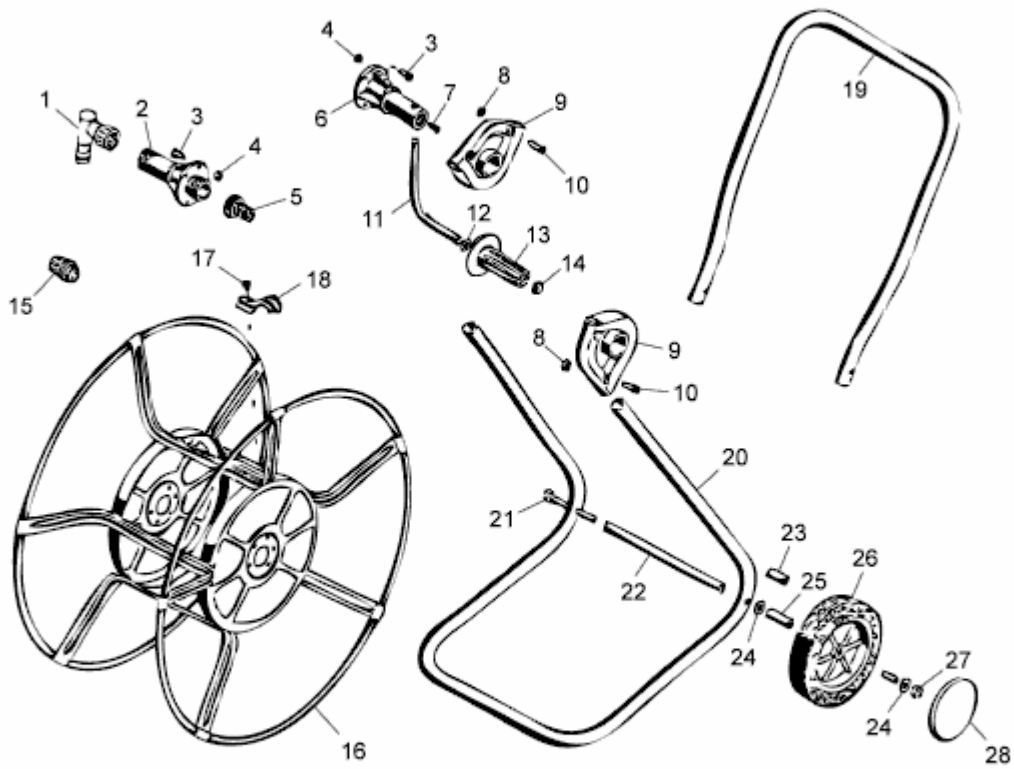

E3-08404A-02