

WS 80 Z > 5223000 (2016) > GRUNDGERÄT

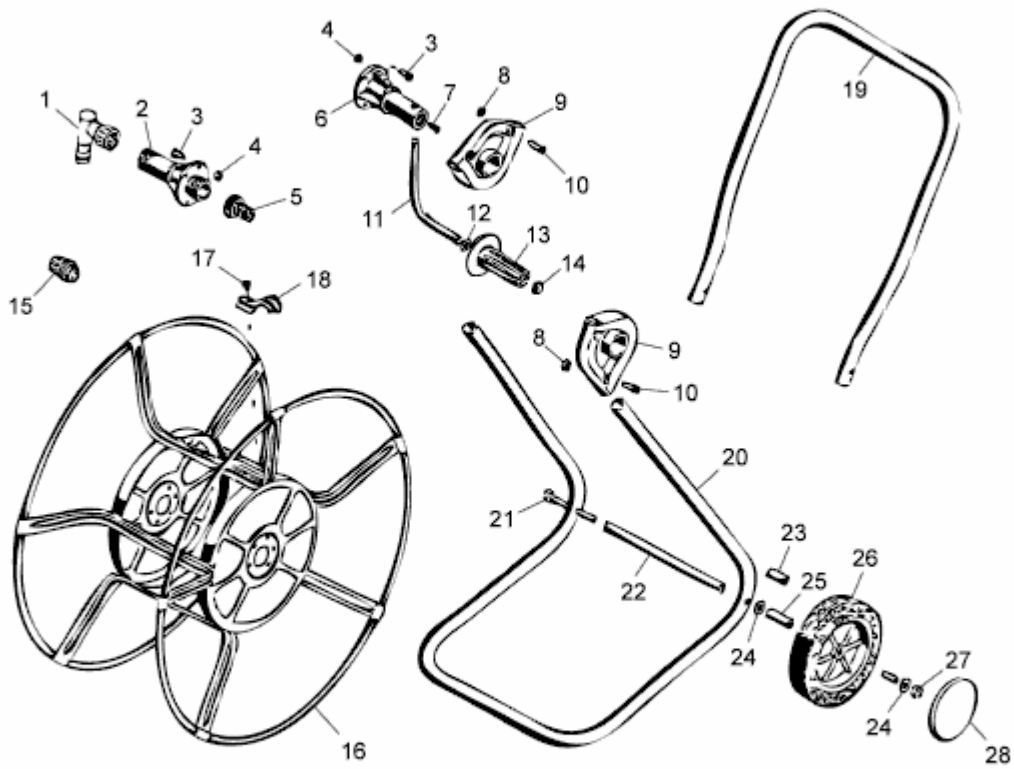

E3-08404A-02