

WS 80 Z > 5223000 (2015) > GRUNDGERÄT

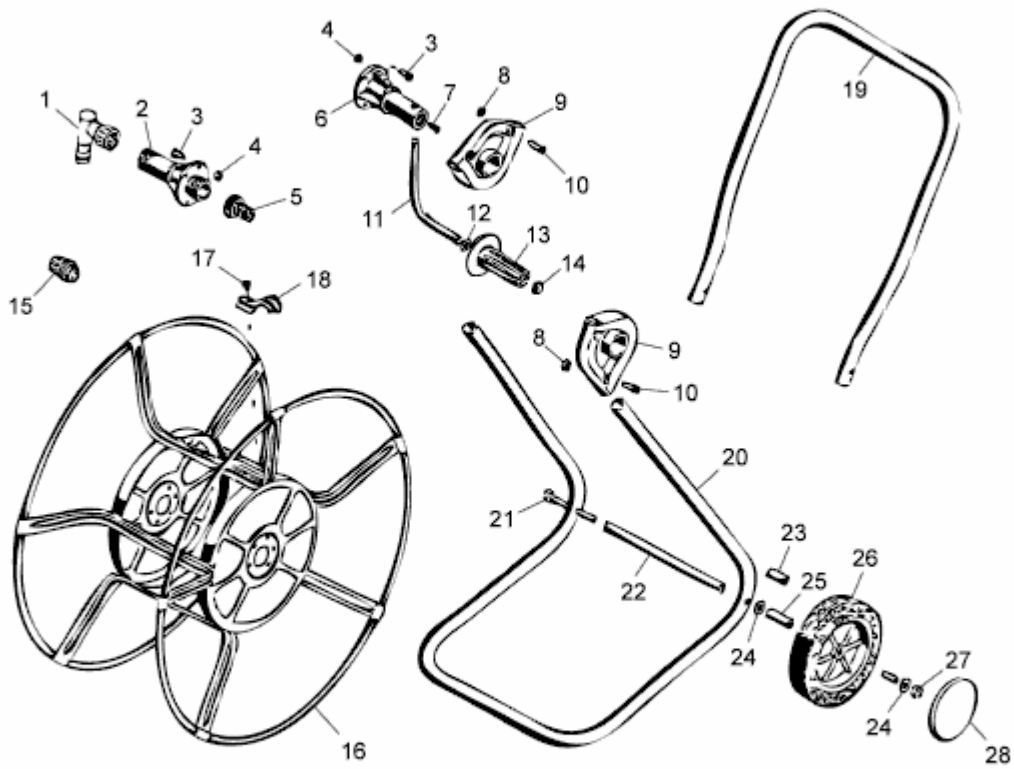

E3-08404A-02