

WS 80 Z > 5223000 (1995) > GRUNDGERÄT

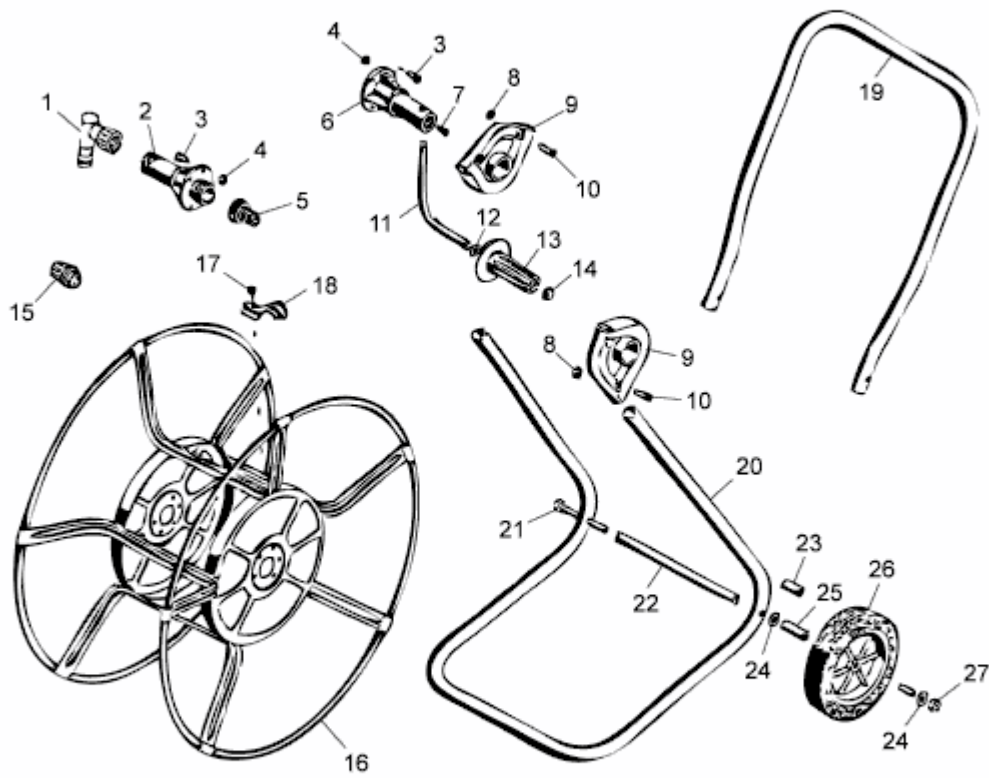

5223000-2