

WS 50 Z > 5222000 (2015) > GRUNDGERÄT

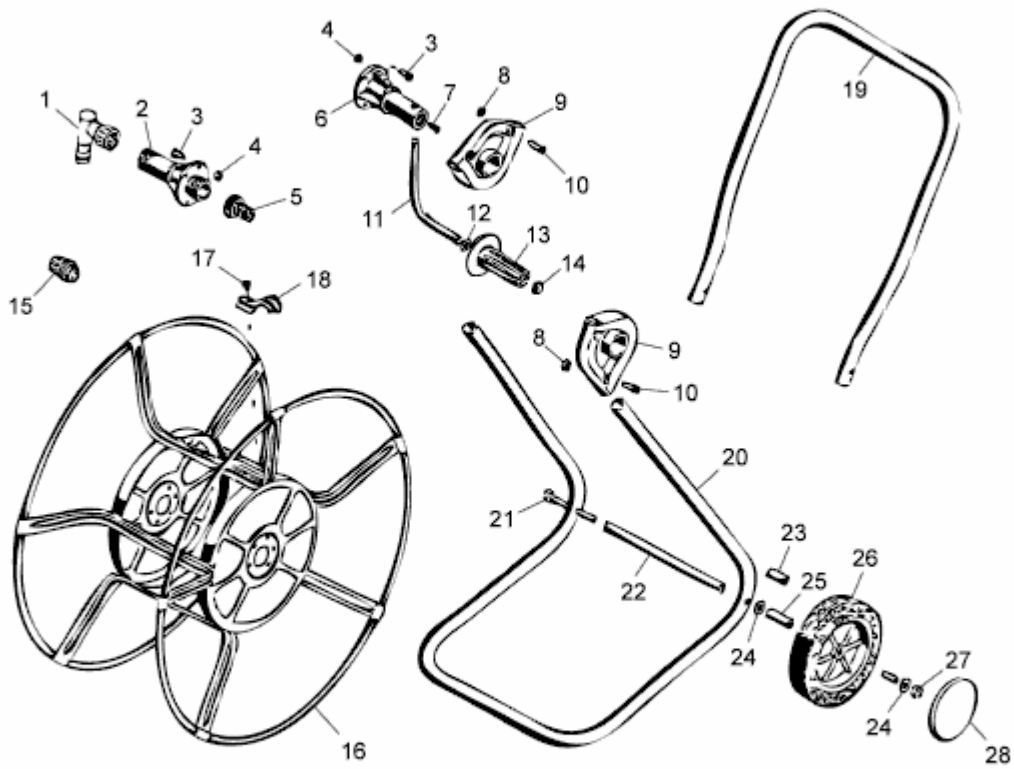

E3-08404A-01