

WS 50 Z > 5222000 (1995) > GRUNDGERÄT

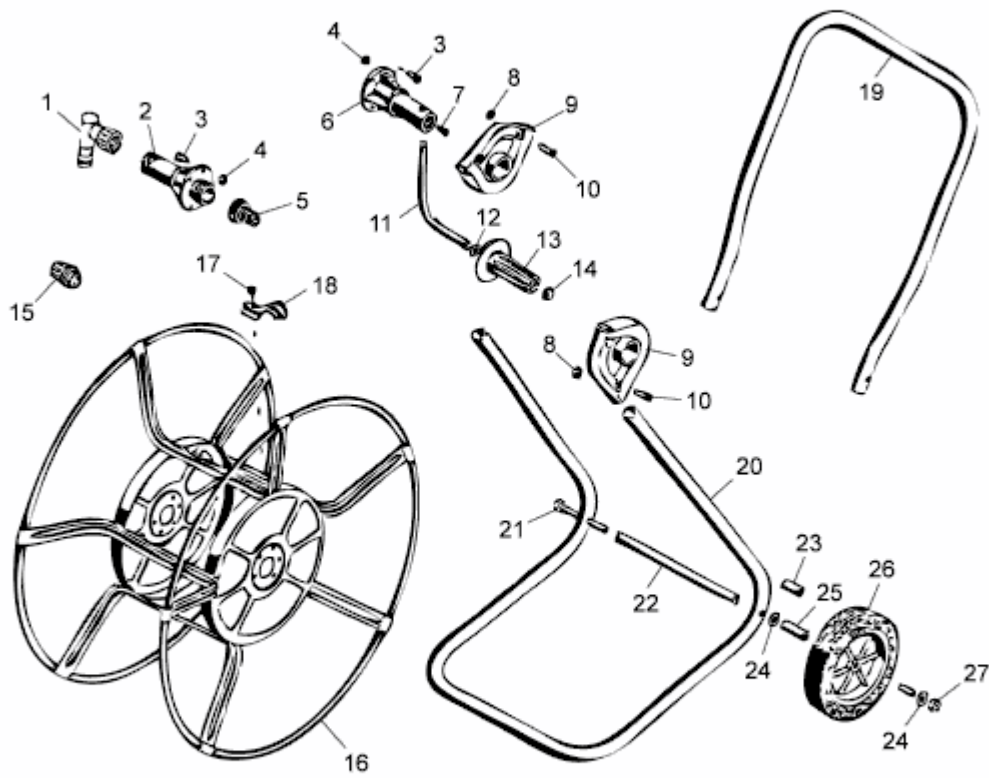

5222000-2