

6.42 ACN > 4943080 SERIE A (1998) > UNTERHOLM

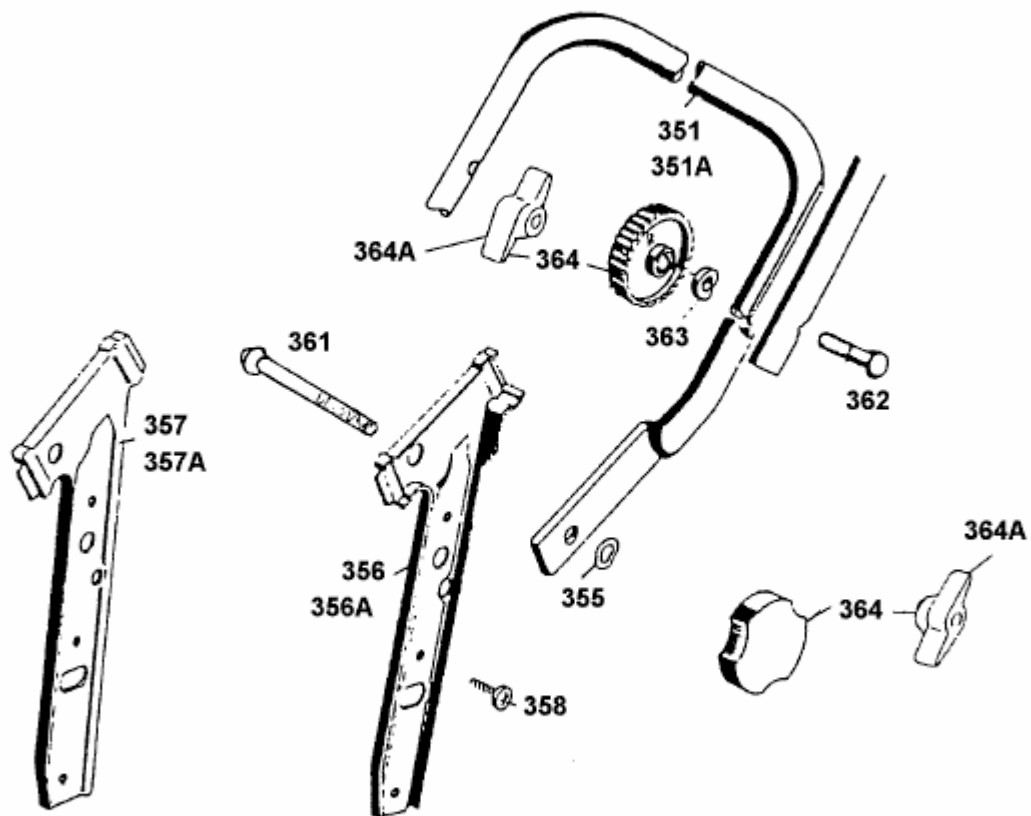

0298_h2