

2.32 E-1 > 4905003 SERIE A (2006) > GRASFANGKORB

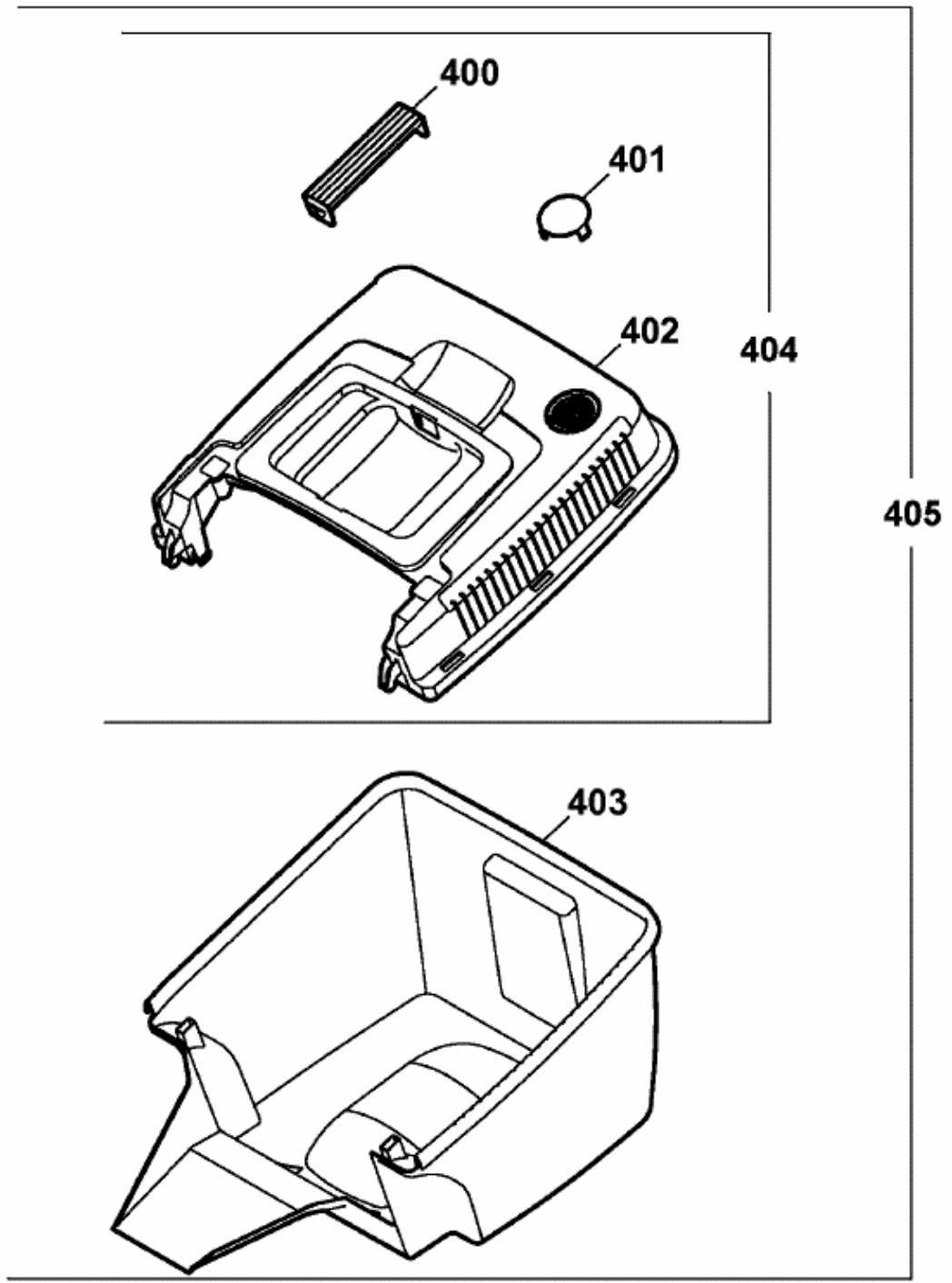

**4905034**