

2.53 BA > 4223000 SERIE E (2007) > RÄDER, SCHNITTHÖHENVERSTELLUNG

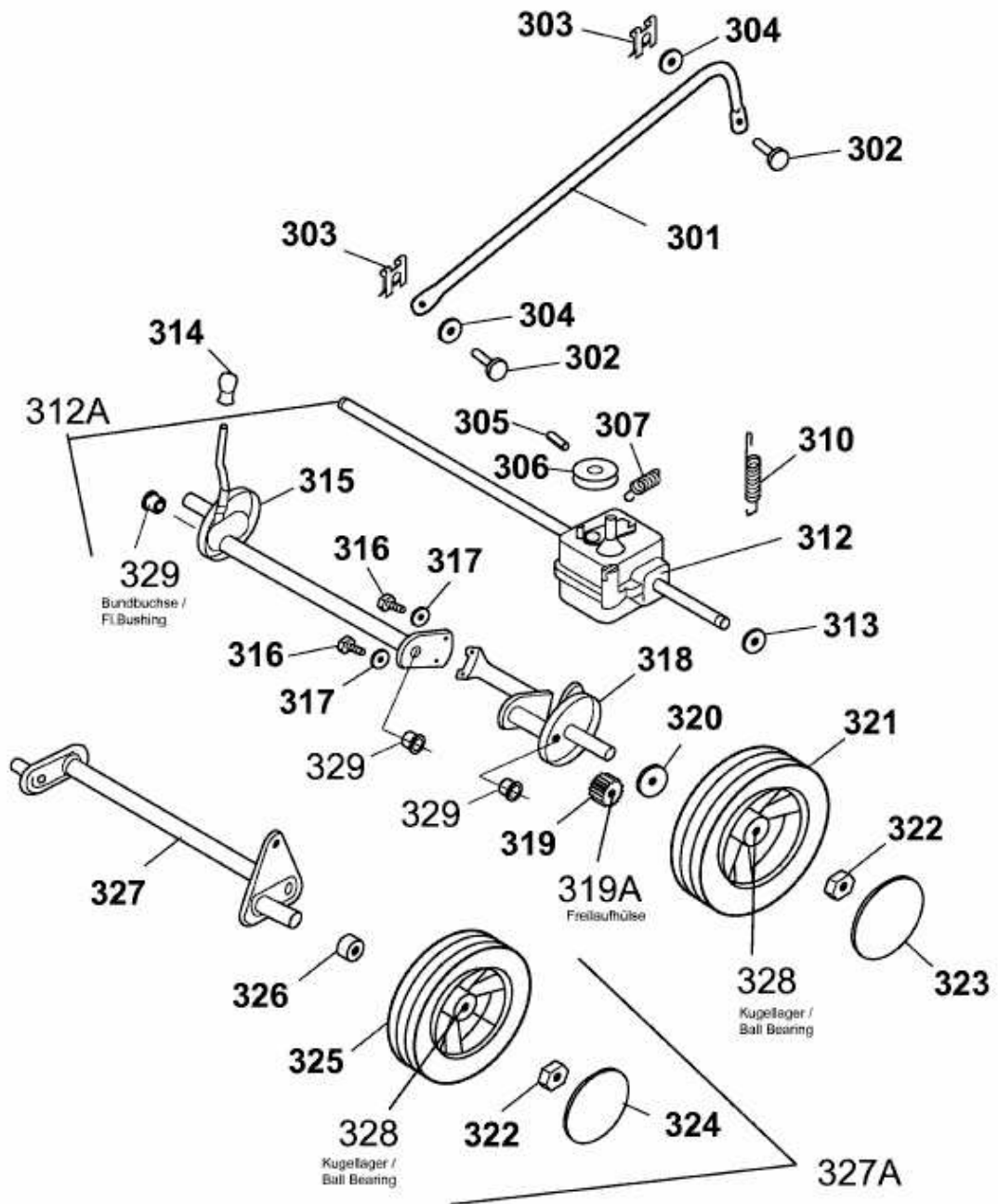

4223000E-2